

# YOUR ONLINE SERVICE MANAGER

NEW FUNCTIONS AND MORE OVERVIEW

## myDMG MORI

New functions for even more service

- + **Consistent end-to-end communication until the problem is solved**  
You can now reach your expert service engineer until the problem is solved via myDMG MORI.
- + **A direct line to the service engineer with guaranteed priority.**
- + **Accept offers in the portal**  
Save time and process your quotations with just a few clicks directly in myDMG MORI.
- + **Identify spare parts**  
You can quickly identify the spare part you need and order or request it.



YOUR HISTORY

YOUR MACHINES

**myDMG MORI**

CUSTOMER PORTAL

YOUR DOCUMENTS

YOUR SERVICE REQUESTS

\*myDMG MORI is currently available in member states of the European Union, the UK, Switzerland, Norway, India, Mexico, Canada, the USA, New Zealand, Australia, Singapore and Malaysia.



You too can benefit!  
Register now for free:  
[myDMGMORI.com](https://myDMGMORI.com)

## SAVE THE DATE 10<sup>th</sup> – 21<sup>st</sup> February 2025

For optimal support we suggest two visiting periods for you:

**Monday, 10<sup>th</sup> February – Friday, 14<sup>th</sup> February 2025**  
+ Focus DACH & NORDICS

**Monday, 17<sup>th</sup> February – Friday, 21<sup>st</sup> February 2025**  
+ Focus EUROPE & INTERNATIONAL

Of course you can visit our Open House at any time.

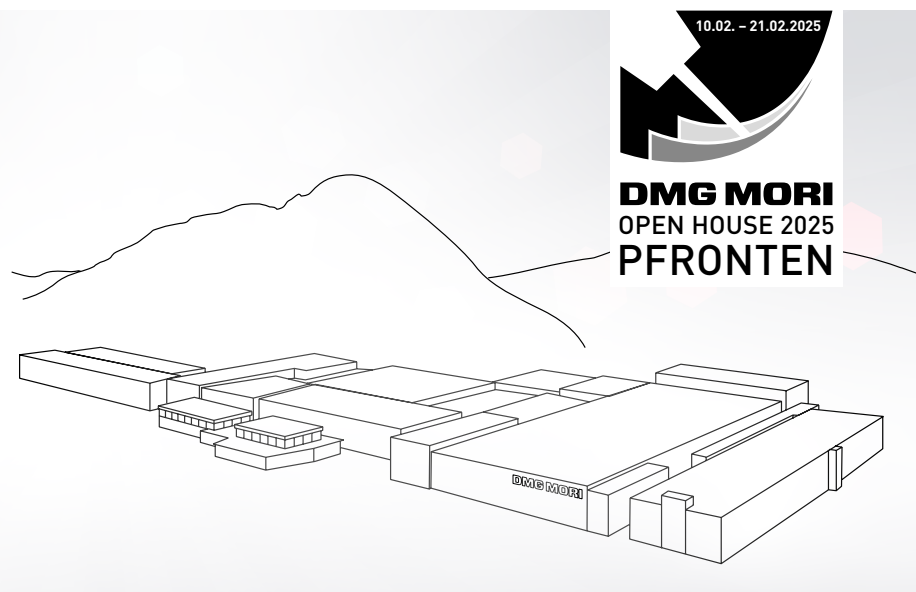

**DMG MORI**  
OPEN HOUSE 2025  
PFRONTEN



All information about  
DMG MORI can be found at:  
[dmgmori.com](https://dmgmori.com)

# DMG MORI

LEGAL NOTICE: DMG MORI Technology Excellence magazine for customers and interested parties.  
Publisher and responsible for content: DMG MORI Global Marketing GmbH,  
Walter-Gropius-Strasse 7, D-80807 Munich, tel: +49 (0) 89 24 88 359 00, info@dmgmori.com  
Subject to technical changes, availability and prior sale.  
Our General Terms of Business shall apply.

# TECHNOLOGY EXCELLENCE



# CELOS X MAPPS SIEMENS

**WORLD  
PREMIERE  
2024**

## NLX 2500 | 700 2<sup>nd</sup> GENERATION

P20C30556\_0124EN

06 **PROCESS INTEGRATION & AUTOMATION**

- MX: Machining Transformation
- Automations Matrix
- Fujii Kenma Co., Ltd.
- **World Premiere:**  
NLX 2500 | 700 2<sup>nd</sup> Generation
- **World Premiere:** CTX 750 | 2000
- Interroll Trommelmotoren GmbH
- **World Premiere:** CTX 350 4A
- AMENT plastics GmbH
- WILHELM BAHMÜLLER Maschinenbau Präzisionswerkzeuge GmbH
- **World Premiere:** CLX 550 TC
- Ultra Machining Company
- Sandvik Coromant Trondheim
- GEA Westfalia Separator
- GRANDE-TEK Flow Control Co., Ltd.
- **World Premiere:** DMV 60/110
- Mechanik-Moduls GmbH
- Max-Planck-Institut für Quantenoptik
- **World Premiere:** DMU 85/95 monoBLOCK 2<sup>nd</sup> Generation
- **Innovation:** PH Cell 500
- Peter Josef Klein Feinmechanik GmbH
- **World Premiere:** DMF 400 | 11
- KUSUDA Co., Ltd.
- TITAN Umreifungstechnik GmbH & Co. KG
- **World Premiere:** NHX 10000  $\mu$ Precision
- **Innovation:** PH-AMR 750
- MICROTECH s.n.c
- Coherent Aerospace & Defense
- **World Premiere:**  
LASERTEC 30 SLM 3<sup>rd</sup> Generation

92 **DX – DIGITAL TRANSFORMATION**

- CELOS X
- ERGOline X
- OP Workbench
- 3D Shopfloor Programming
- TULIP
- Airbus Helicopters Deutschland GmbH

108 **GX – GREEN TRANSFORMATION**

- MX: Webspecial
- PWS Presswerk Struthütten GmbH
- Desert View High School

118 **FULL-SERVICE**

# EXPLORE THE WORLD OF

# MX MACHINING TRANSFORMATION

→ from page 12

## WORLD PREMIERES 2024



## PROCESS INTEGRATION & AUTOMATION

→ from page 06



**READY AVAILABILITY OF SPARE PARTS THANKS TO AUTOMATED PRODUCTION**  
GEA Westfalia Separator (Germany)  
Process Integration & Automation: Turn & Mill/Workpiece handling



**100-YEAR-OLD MANUFACTURER EMBRACES INNOVATION WITH INH 63**  
KUSUDA Co., Ltd. (Japan)  
Process Integration & Automation: 5-Axis Milling/Pallet handling

## DX – DIGITAL TRANSFORMATION

→ from page 92



**COMPONENTS PROGRAMMED VIRTUALLY**  
Airbus Helicopters Deutschland GmbH (Germany)  
DX – Digital Transformation: Digital Twin

## GX – GREEN TRANSFORMATION

→ from page 108



**AUTONOMOUS SERIES PRODUCTION FOR E-MOBILITY**  
PWS Presswerk Struthütten GmbH (Germany)  
GX – Green Transformation: Green Tech

# MX – MACHINING TRANSFORMATION

## WHY 5-AXIS MACHINING?

With 5-axis machining, you can machine 5 sides of a part in a single setup. This means you can reduce your production costs by reducing the number of fixtures, using standard tools, etc. You also reduce machining time and increase accuracy by eliminating manual reclamping. 5-axis machining is also the basis for further process integration, e.g. turn-mill, mill-turn, grinding, gear cutting, etc.

## WHY MX – MACHINING TRANSFORMATION?

The needs of society change drastically every 10 years. We have continuously developed our business model in order to fulfill these needs with new products and services. We are driving forward with **Process Integration, Automation, Digital Transformation (DX)** and **Green Transformation (GX)**.

## THERE IS NO RIGHT WAY – IT IS YOUR OWN WAY TO MX!

No matter where you start ...  
 No matter what your next step is ...  
 → Go your own way with MX

## EXPLORE THE WORLD OF MX

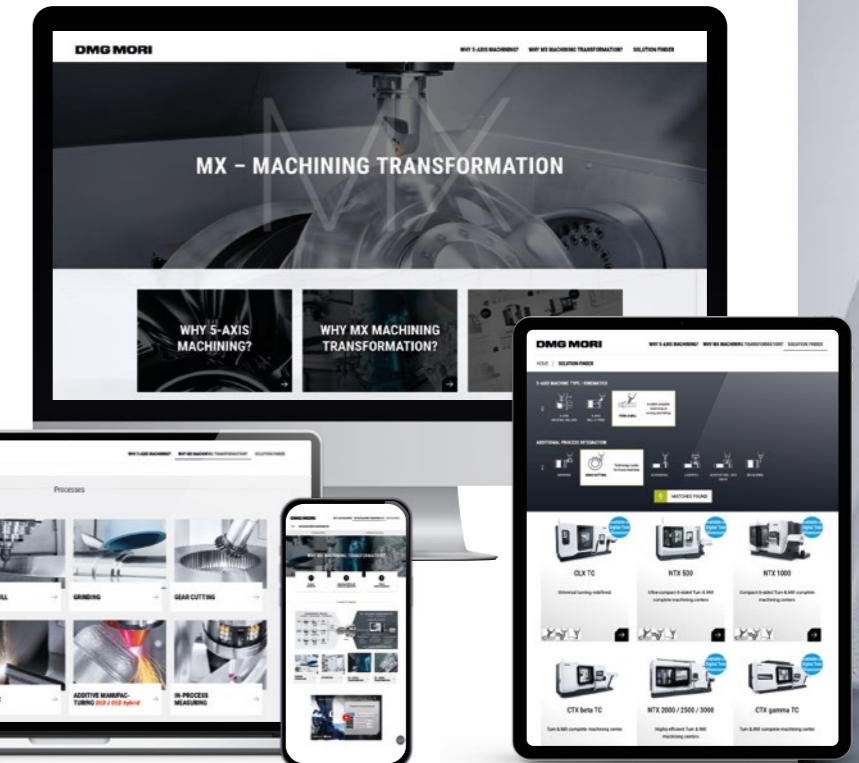

You can find our web special at:  
[transform.dmgmori.com](https://transform.dmgmori.com)

### EXAMPLE 1

## PROCESS INTEGRATION GEAR CUTTING

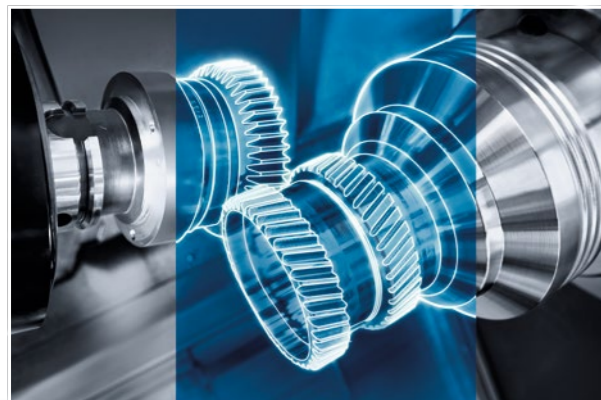

**DIGITAL TRANSFORMATION (DX)**  
 → Simply realized through technology cycles

**GREEN TRANSFORMATION (GX)**  
 → Resource-saving – use of one machine instead of several machines

### EXAMPLE 2

## AUTOMATION – ALSO FOR RETROFITTING



**DIGITAL TRANSFORMATION (DX)**  
 → Increased machine utilization – even in unmanned shifts

**GREEN TRANSFORMATION (GX)**  
 → Simple operation via the control system

# GLOBAL LEADER IN AUTOMATION SOLUTIONS – FROM STANDARD TO CUSTOM 14 PRODUCT LINES AND 59 PRODUCTS



- LPS Gen. 4**
  - + For Pallet Systems
  - + For PH-AMRs
  - + For Central Tool Storage (CTS) [by CTS Server]
- MATRIS Controller**
  - + For Robot systems (excl. Robo2Go)
  - + For WH-AMRs
- DMG MORI Cell Controller** (available on request)
  - + For control of multiple DMG MORI automation cells
- additional**
  - + Robo2Go App
  - + MATRIS Light Controller
  - + Pallet Master

WORKPIECE HANDLING		PALLET HANDLING		TOOL HANDLING
Gantry Loader	Robot	Round Storage System	Linear Storage System	Central Tool Storage – Wheel Type
TURNING		MILLING		
▶		▶		

AMR – AUTONOMOUS MOBILE ROBOT (WORKPIECE, MATERIAL, CHIP, PALLET & TOOL HANDLING)				
WH-AMR	AMR for Material Handling	AMR for Chip Handling	PH-AMR	AMR for Tool Handling
TURNING & MILLING			MILLING	
▶			▶	

# ROAD TO BECOMING THE NO. 1 ROBOT-WORKSHOP

Fujii Kenma Co., Ltd. was founded in 1970 in Kato City, Hyogo Prefecture, and specializes in machining of metal parts for automobiles as well as agricultural and heavy machinery. With ten technicians and multiple turning and machining centers, Fujii produces a wide variety of parts according to customer needs.

To automate its existing production processes, the company invested in its first MATRIS Light robot system in May 2022. As productivity greatly improved, two additional MATRIS Light units with the Vision Camera option followed just six months later.

## MATRIS Light – compact & fence-free

Mr. Akihiro Fujii, Senior Managing Director, explained the reason for the 3-part investment: “Originally, we had to divide the production processes of many products across multiple machines, and even after adding a turning center for process integration, productivity did not increase as much as we had

hoped. We also encountered problems with operator illness, which often made us change our plans and work overtime to meet deadlines. Introducing robots and automating production was our only chance.”

## ROBOT INTRODUCTION WITH UNCHANGED FACTORY LAYOUT

With MATRIS Light, production has doubled from about 1,500 to 3,000 units per month. The system has also eliminated manual errors and reduced the cost of training operators, allowing the company to “focus on creative work that only people can do,” says Fujii.

“Robots from other companies require safety fences and layout changes to existing facilities, but MATRIS Light is a fence-free collaborative robot. Basically, we only had to place it in front of the turning center. And this made it the perfect choice for us, as it eliminated the need for layout changes, which would have been time-consuming and costly.”

## Realizing around-the-clock, automated production

Fujii Kenma utilizes MATRIS Light for the automatic transfer of a wide variety of workpieces. Although MATRIS Light was initially not designed with 24 hours of continuous production in mind, the company implemented its own innovations to make it possible and maximize robot usage. One of the innovations was an in-house designed table for holding the workpieces prior to machining instead of a standard workpiece stocker.

“*MATRIS Light is constantly learning and getting smarter to meet our needs – throughout the whole night when people are asleep, without asking for overtime pay, and is ready for production again next morning.*”

**Akihiro Fujii**  
Senior Managing Director  
Fujii Kenma Co., Ltd.



**24-HOUR  
OPERATION**

**2x  
PRODUCTIVITY**

MATRIS Light

## AUTOMATION SYSTEM WITH EASY SETUP THAT CAN BE USED IN A SMALL FOOTPRINT

- + A freely movable robot system with a robot arm & workpieces mounted on a cart
- + Collaborative robot without fence
- + No major infrastructure changes required for robot installation
- + Robot and workpieces mountable on separate carts to enable setup of next workpiece during operation
- + With direct teaching for robot control without special know-how



A video about MATRIS Light is available on our website:  
[youtu.be/mDQU0gclRw](https://youtu.be/mDQU0gclRw)



Smart table design to accommodate the MATRIS Light cart and save space

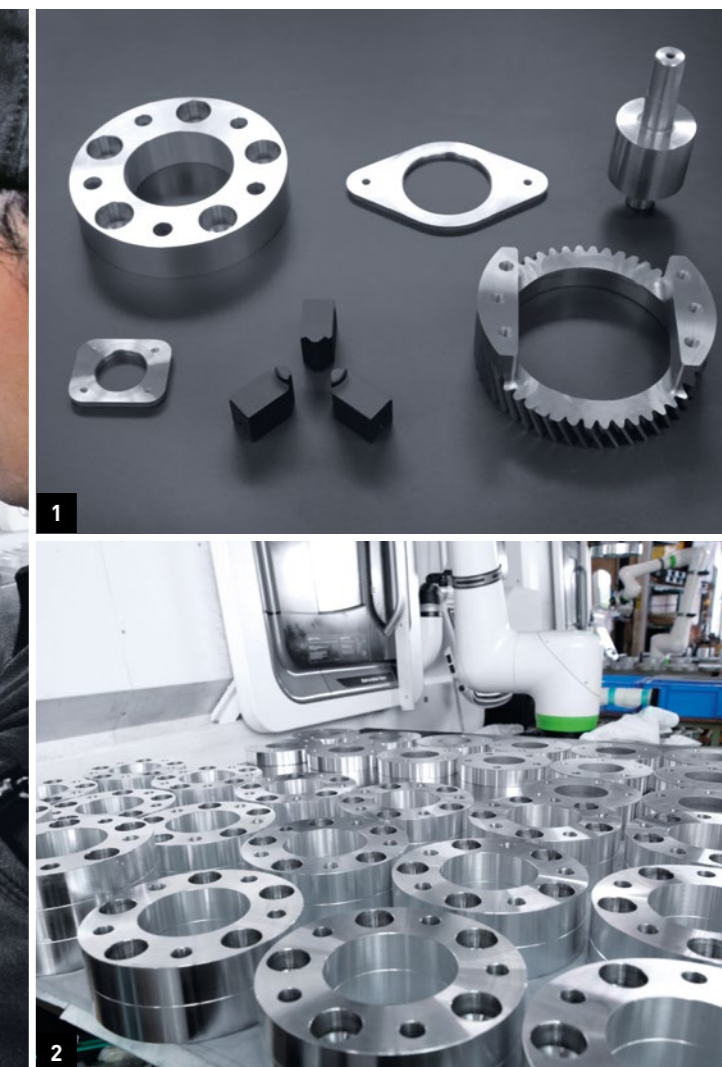

Easy configuration via a tablet.

1. Main workpieces. The jaws for clamping the workpiece were also designed in-house. 2. Workpieces are stacked for long hours of continuous operation.



Vision Camera automatically detects the workpiece location and adjusts the arm motion to continue production regardless of misalignments.

"We designed this table to allow the MATRIS Light cart to move under it and to make full use of the motion range of the robot arm for stacking the workpieces from the front to

## MORE THAN TWICE THE PRODUCTIVITY FOR SHORTER LEAD TIMES AND NEW BUSINESS OPPORTUNITIES

the back. The factory floor is slightly sloped to improve drainage and we adjusted the height of both ends of the table by several millimeters to ensure secure workpiece

clamping by the robot arm", Mr. Fujii recalls. But even if the table is slightly misaligned, no problem. Two subsequent units of MATRIS Light are equipped with Vision Camera as an option to automatically detect the workpiece position and adjust the arm motion accordingly. And this is how Fujii Kenma's unique innovations together with the latest MATRIS Light functions realized uninterrupted, automatic production even during unmanned night shifts.

### Training and utilizing robots for further automation

Mr. Fujii describes the advantage of MATRIS Light with its operability, easy teaching and perfect job repeatability. "MATRIS Light gets smarter day by day, works non-stop throughout the night when people are asleep, and gets up for work again in the morning to meet its production schedule, all without demanding overtime pay. You see, I can only be grateful

to MATRIS Light," Fujii says with a smile. In the future, Fujii hopes to increase the number of MATRIS Light units to realize a production site with fully automated workpiece transfer.

In so doing, this will create extra time for more challenging tasks only humans can do, which raises everyone's motivation and skills. Fujii Kenma will continue its road towards becoming the No. 1 robot-workshop and challenge itself to further extend automation.

### FUJII KENMA FACTS

- + Established in 1970
- + 10 employees
- + Provides diverse metal parts for automobiles, robots, heavy machinery, construction and agricultural equipment, water heaters, etc.
- + In-house production of fixtures with 3D scanners and 3D printers

 有限会社フジ研磨

Fujii Kenma Co., Ltd.  
109 Kamikume, Kato-city,  
Hyogo 673-1414, Japan  
[www.fujiikenma.moo.jp](http://www.fujiikenma.moo.jp)



**WORLD  
PREMIERE  
2024**

# NLX 2500 | 700 2<sup>nd</sup> GENERATION

## STATE OF THE ART UNIVERSAL TURNING



### M<sup>X</sup> READY FOR AUTOMATION

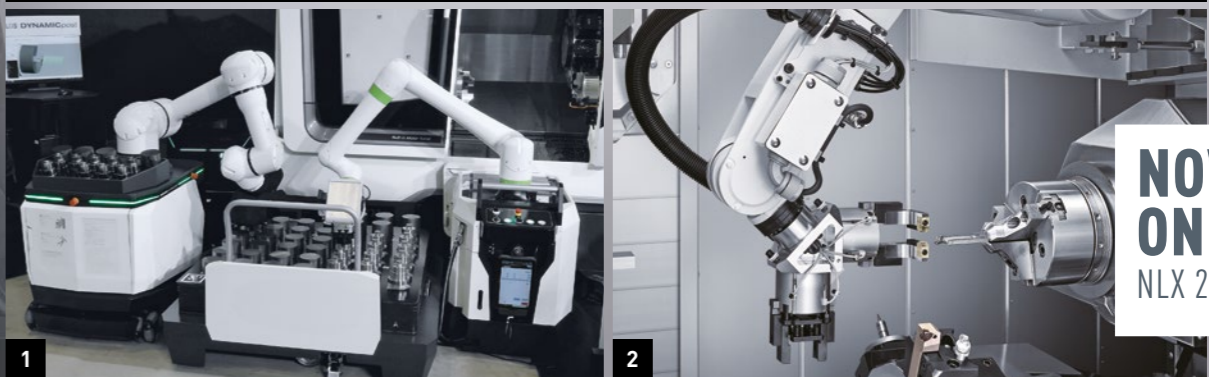

**NOW  
ON  
NLX 2500**

Optimize your setup times with the WH-AMR + MATRIS Light (1) or IMTR (2) solutions. Further automation solutions: Gantry loader, MATRIS, Robo2Go Turning, Barloader & Workpiece unloader.

### PERFECT CHIP, COOLANT & MIST SOLUTION



**Stainless steel cover**  
for smooth chip flow



**zero-sludgeCOOLANT pro:**  
Innovative vertical coolant tank



**zeroFOG:** Built-in mist collector

NC Clamp function:  
Pressure command,  
chuck stroke linear detection,  
inching function, etc. on  
ERGOline X as standard

**NEW**



MAPPs  
CELOS X  
SIEMENS

#### HIGHLIGHTS

- + Workpieces up to  $\phi 366 \times 708.6$  mm
- + Y-axis with 120 mm travel ( $\pm 60$  mm) as standard
- + Bar machining up to  $\phi 105$  mm at left and right hand spindles
- + 6-sided complete machining due to right hand spindle (option) up to 7,000 rpm or 577 Nm
- + BMT turret with 10, 12 or 20 tool stations
- + VDI turret with 12 tool stations
- + NEW: 400 V

#### IMPROVED TECHNOLOGY FOR EVEN HIGHER RIGIDTY & ACCURACY

- + Ball Screw Core Cooling
- + Ambient Temperature Alarm
- + Spindle now with cooling water circulation
- + Double anchor fixed feed-drive
- + 22% bigger roller guideways at 55 mm

#### INTUITIVE, SIMPLE, EFFECTIVE

- + Simplified operation **reducing human errors**
- + Full overview of your machines **everywhere**
- + Your optimization for **DX & GX**
- + **CELOS X on MAPPs & SIEMENS**

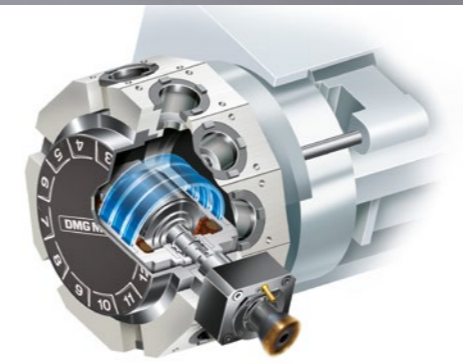

#### NEW BMT UNIT ENHANCE YOUR POSSIBILITIES!

- + More in machine tool usage and reduced chip to chip time with automatic tool change
- + High speed up to 12,000 rpm and 86 Nm\*
- + High torque up to 6,000 rpm and 100 Nm\*

#### turnMASTER SPINDLES



**36 MONTHS  
WARRANTY  
WITH UNLIMITED  
SPINDLE HOURS**

Left hand spindle	
<b>NEW:</b> 10 inch   5,000 rpm   843 Nm   $\phi 105$ mm (bar)	
12 inch*   3,000 rpm   1,273 Nm   $\phi 105$ mm (bar)	
Right hand spindle*	
6 inch   7,000 rpm   95 Nm   $\phi 35$ mm (bar)	
8 inch   5,000 rpm   207 Nm   $\phi 72$ mm (bar)	
<b>NEW:</b> 10 inch   5,000 rpm   577 Nm   $\phi 105$ mm (bar)	*option

**WORLD  
PREMIERE  
2024**

# CTX 750 | 2000

UNIVERSAL TURNING MACHINE  
WITH 2,040 mm TURNING LENGTH

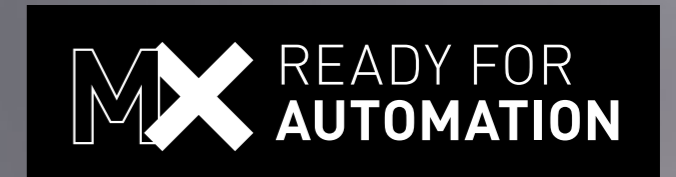

Ready for automation e.g. with **MATRIS** or **Robo2Go Max** for shaft-type parts up to dia. 200 mm, 1,200 mm length and up to 115 kg weight with one gripper.



**NEW**  
10 % BIGGER  
TURNING DIA.  
(700 mm)

### HIGH ACCURACY AND RIGID MACHINE DESIGN

- + Holistic cooling concept and direct scales by MAGESCALE in X, Y and Z
- + High positioning accuracy within 6 microns / 12 arcseconds
- + Wide linear guideways up to 55 mm for high rigidity

### SPINDLES UP TO 3,250 rpm OR UP TO 1,975 Nm

- + Left hand spindle: ISM 102 with 3,250 rpm and max. 770 Nm, or ISM 127 with 2,500 rpm and 1,975 Nm optional
- + Right hand spindle: ISM 80 with 4,000 rpm and max. 360 Nm, or ISM 102 with 3,250 rpm and max. 770 Nm optional
- + Bar machining up to  $\varnothing 127$  mm

### GREENMODE FOR UP TO 10% REDUCED ENERGY CONSUMPTION

- + Energy monitoring and advanced DMG MORI Auto Shutdown
- + Synchron spindle drives and class IE3 motors
- + Hydraulics and coolant with inverter technology
- + Minimized compressed air consumption
- + Low friction linear guideways with grease lubrication

### HIGHLIGHTS

- + 6-sided complete machining of workpieces up to  $\varnothing 700 \times 2,040$  mm with  $\pm 85$  mm Y-axis
- + Spindles up to 3,250 rpm or up to 1,975 Nm
- + VDI 50 turret up to 6,000 rpm or 86 Nm
- + Ready for automation, e.g. with the Robo2Go Max or MATRIS

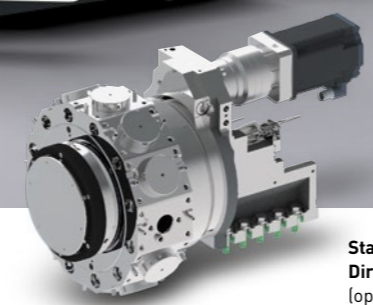

Star type turret  
DirectDrive VDI 50  
(option)

### HIGH MILLING PERFORMANCE

- + Wide range of tool turrets fully ready for high pressure coolant (up to 80 bar)
- + VDI 50 turret with 4,000 rpm and 84 Nm
- + High speed turret with 6,000 rpm and 66 Nm optional
- + DirectDrive turret with 6,000 rpm and 86 Nm optional

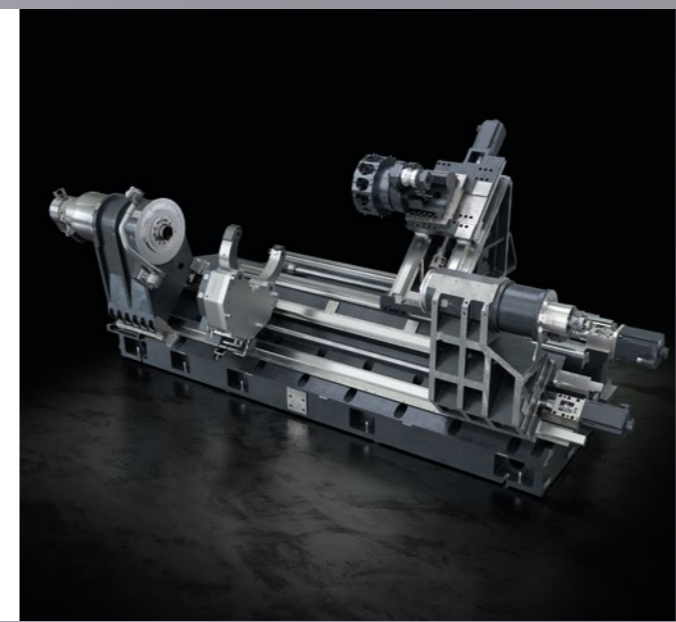

### 24" ERGOline X PANEL WITH SINUMERIK ONE AND CELOS X

- + Intuitive, simple, effective
- + Simplified operation reducing human errors
- + Full overview of your machines everywhere
- + Your optimization for DX & GX
- + Also possible with DMG MORI SLIMline Oi-F Plus FANUC touch control 19"





# RAPID RESPONSE PRODUCTION THANKS TO FLEXIBLE AUTOMATION

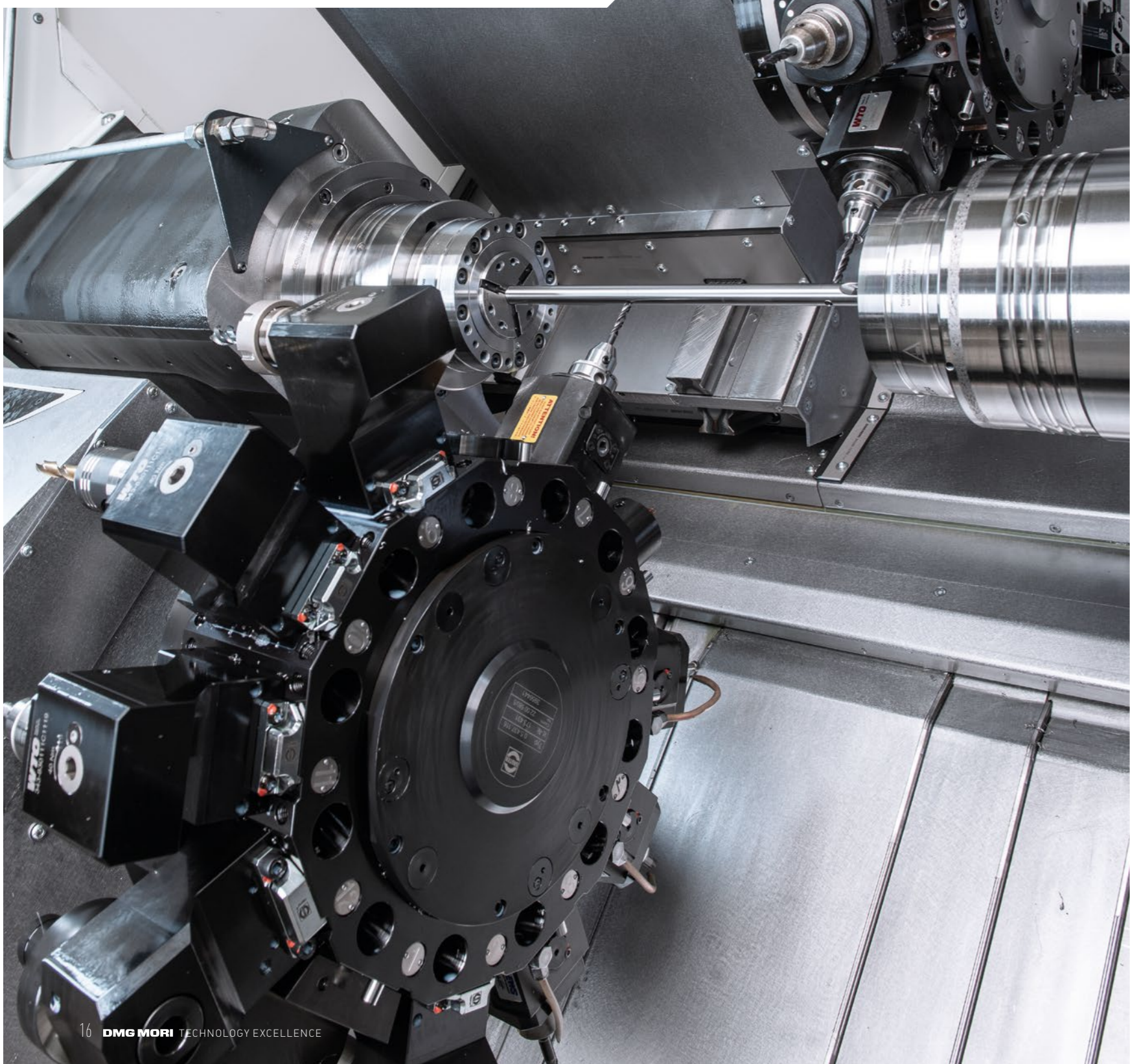

“*Unscheduled downtime is a serious problem for our customers. Thanks to the automated CTX beta 800 4A, we can deliver customized motors within 5 days.*”

**Thomas Baack**  
Managing Director  
Interroll Trommelmotoren GmbH



Founded in 1959, the Swiss Interroll Group is a leading global provider of material flow solutions. Its customers include industry giants from the food industry, online retail and other sectors – including Amazon, Procter & Gamble, Bosch and Nestlé. Within the Group, Interroll Trommelmotoren GmbH from Hückelhoven is a manufacturer of roller and drum motors. Development is carried out jointly with Interroll Innovation GmbH. The company was integrated into the Group in 2006 and employs 211 specialists. To ensure the reliability of the customer’s material flow and minimize downtime, the drum motors are produced and delivered within five days – or even within 24 hours for special service offers. However, this requires highly productive manufacturing. Interroll has been relying on automated production solutions from DMG MORI since 2018. Following delivery of a cell with two CTX beta 1250 4A lathes and robotic automation, a CTX beta 800 4A with bar loader and automatic parts removal was installed in 2024.

**Individual motors within within 5 days**  
“Continuous material flow is the backbone of numerous applications in logistics and industry,” says Thomas Baack, Managing Director of Interroll Trommelmotoren GmbH, explaining the need for reliable motors in a

Interroll promises its customers delivery of motors within five days. A modular product platform makes this possible. The motors can be configured to meet individual requirements. According to Alexander Leven, who is responsible for industrial engineering, this poses major challenges in production: “We have to plan our capacity and orders in such a way that we can manufacture the individual components flexibly before the motors are assembled and tested.” The aluminum, steel and stainless steel components have been manufactured on DMG MORI lathes since 2006. They process the small batch sizes reliably, with high precision and in short throughput times. “The CTX beta 800 4A in particular with two spindles and two turrets is highly flexible thanks to 6-sided complete machining,” explains Alexander Leven. “We can either perform two successive operations on one component at the spindles or machine two workpieces at the same time.”

## FLEXIBLE AND HIGHLY PRODUCTIVE MACHINING ON THE CTX beta 800 4A

wide variety of designs. Size, performance, temperature resistance and hygienic design are individual factors that lead to a wide range of products. After all, material can flow anywhere – in the production and packaging of food, in industrial assembly line production, in baggage handling at the airport or in the handling of large pallets. “Unscheduled downtime is a serious problem in any of these areas because it costs time and money.”

Interroll produces drum motors in Hückelhoven-Baal; drives that enable energy-efficient unit load transportation.





On the CTX beta 800 4A, Interroll manufactures components for drum motors fully automatically from loading to unloading.



The bar feeder has eight guide channels so that the machine can process different jobs flexibly.



Longer workpieces are output through the right hand spindle of the CTX beta 800 4A and collected in the unloading system.

CTX beta 800 4A

## 4-AXIS PRODUCTION TURNING

- + Turning diameter up to  $\varnothing 340$  mm and turning length up to 800 mm
- + Bar machining up to  $\varnothing 102$  mm
- + 2x12-station VDI 40 DirectDrive-turrets with 10,000 rpm and 34 Nm for maximum material removal
- + Y-axis on both turrets (top  $\pm 60$  mm, bottom  $\pm 40$  mm) for productive complete machining of bar, shaft and chuck parts
- + Optional TWIN concept with two independent working areas through transverse movement of the counter spindle tailstock combination

As the drive of drum motors is located inside the units, they take up less space than conventional motors and therefore help to optimize the installation area. In addition, drum motors score points with their hygienic design, which meets the strict requirements of the food and pharmaceutical industries. Their smooth surfaces and enclosed design prevent the ingress of dirt and make cleaning much easier, thus meeting the highest

## FLEXIBLE AND HIGHLY PRODUCTIVE PRODUCTION ON THE CTX beta 800 4A

hygiene standards. The aluminum, steel or stainless steel components of these diverse products have been manufactured on DMG MORI lathes since 2006. They machine the small batch sizes reliably, to high precision and in short throughput times. "In particular, the CTX beta 800 4A with two spindles and two turrets is highly flexible thanks to 6-sided complete machining" explains Alexander Leven. "We can either

perform two successive operations on one component at the spindles or machine two workpieces at the same time."

### Automated production since 2018

In the past, manual activities such as clamping and removing the workpieces accounted for a relatively large proportion of what was actually a short machining process. Automated handling was therefore the logical consequence. Alexander Leven, who designs such production solutions together with his colleagues André Honigs and Mehmet Özcan, remembers the first autonomous production cell: "In 2018, DMG MORI installed two CTX beta 1250 4A lathes, which are loaded and unloaded by a robot." Such solutions are a huge benefit. "Employees have more time for preparatory tasks and quality control."

### Flexible & automated turn-mill processing of bar stock

While the first automated production cell is loaded by a robot, the CTX beta 800 4A installed in 2024 processes bar material up to 1,600 mm in length – also fully automatically. The large variety of parts can be manufactured due to the provision of bar magazines with eight guide channels, allowing bars of different diameter to be selected depending on the order.

Short components are removed using a gripper in the machining area and a parts dispenser. Longer workpieces are output by the right hand spindle and picked up by an unloading system. Communication between loading and unloading ensures that the bar material is used optimally and in a resource-saving manner.

### Complete machining including in-process measurement and marking

In addition to turning and milling operations, the 6-sided machining of the motor components includes engraving of the workpieces and in-process measurements to relieve the burden on quality control. The digital networking of the CTX beta 800 4A also makes programming easier. As there are numerous

variants of a component, only a few parameters such as the length and diameter need to be changed. The control system obtains this data from the company's SAP system. In this way, orders can be prioritized even faster at short notice.

### Labor shortage promotes automation solutions

Thomas Baack sees future development as economically positive. "The shortage of labor will further promote the automation of material flows and thus the demand for our solutions." The product portfolio is ideally positioned for further growth. The same applies to motor production, as Alexander Leven adds – also with a view to future lathes from DMG MORI: "The high level of

flexibility in production and consistent automation, including for new machine acquisitions, will further strengthen our competitiveness."

«



You can find a video on the CTX beta 800 4A here: [youtu.be/KVaK5T5ZGE](https://youtu.be/KVaK5T5ZGE)



The range of components machined on the CTX beta 800 4A includes a wide variety of drum motor components.

### INTERROLL FACTS

- + Incorporated into the Swiss Interroll Group in 2006
- + 211 specialists at the company headquarters in Hückelhoven
- + Production of drum motors for material flow solutions



Interroll Trommelmotoren GmbH  
Opelstraße 3  
41836 Hückelhoven, Germany  
[www.interroll.com](http://www.interroll.com)



**WORLD  
PREMIERE  
2024**

# CTX 350 4A

## PRODUCTIVE UNIVERSAL TURNING WITH TWO TURRETS AND UP TO 28 TOOL POSITIONS

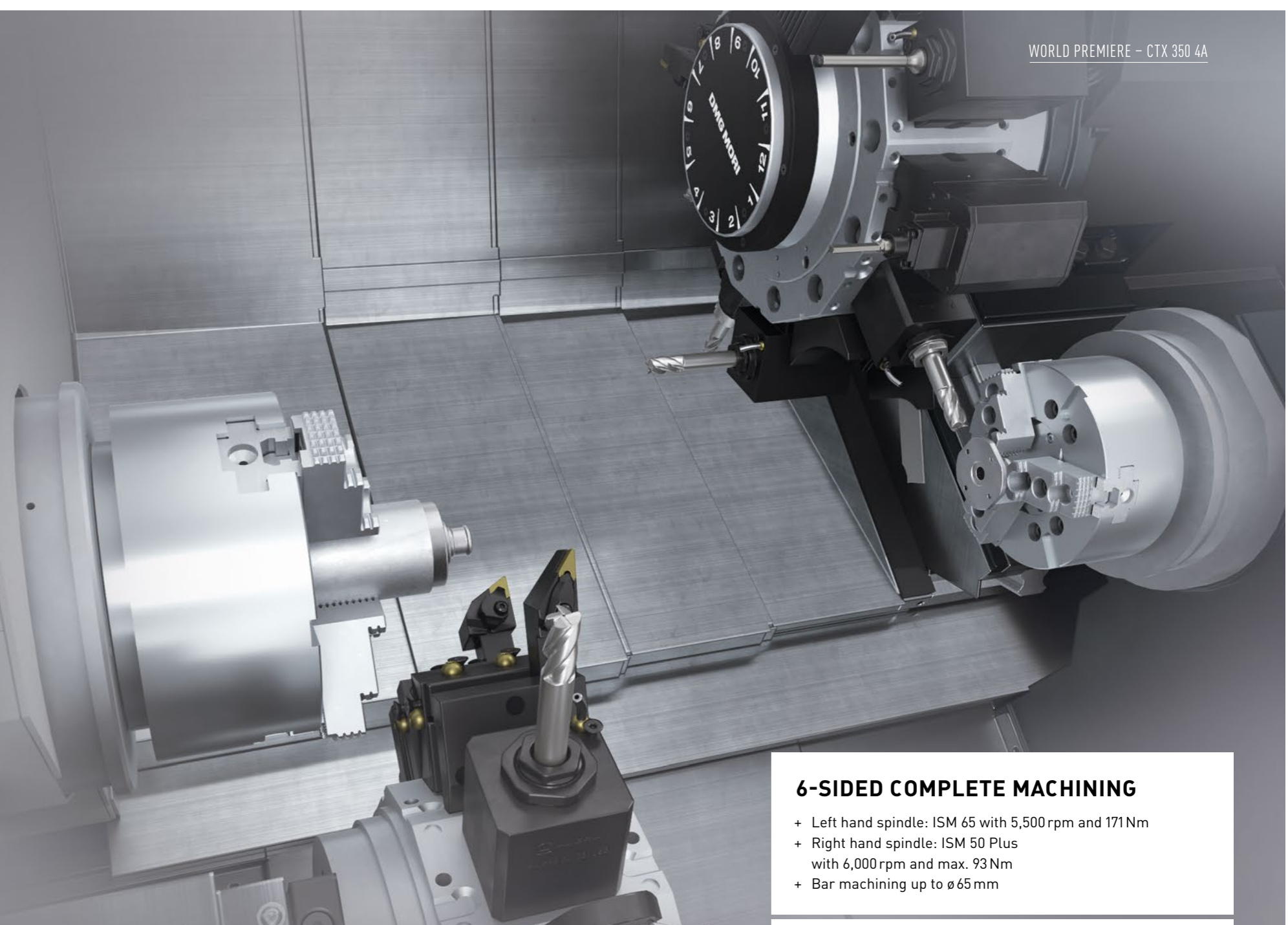

### HIGHLIGHTS

- + 6-sided complete machining of workpieces up to  $\varnothing 200 \times 100$  mm and  $\pm 50$  mm Y-axis in a 8.1 m<sup>2</sup> footprint
- + Spindles up to 6,000 rpm or up to 171 Nm
- + Bar machining up to  $\varnothing 65$  mm
- + Upper turret and lower turret with 12 VDI 30 tools each / optional 16 VDI 30 tools for upper turret / All tool stations driven up to 12,000 rpm or 17 Nm / Up to 80 bar coolant pressure
- + State-of-the-art CNC with CELOS X on SINUMERIK One or native FANUC 0i TFPlus
- + **GREENMODE** for up to 10% less energy consumption, e.g.:
  - Energy monitoring and advanced DMG MORI Auto Shutdown
  - Synchronous spindle drives and class IE3 motors
- + Large set of technology cycles for simplified programming of complex operations or to monitor cutting processes

**MX** READY FOR  
**AUTOMATION**



- + Unloading device for workpieces up to  $\varnothing 65 \times 100$  mm and 3 kg as standard
- + Various automation solutions, also retrofittable, e.g.
  - Bar loader, Robo2Go Turning, MATRIS Light

“ Following our MX-transformation fundamentals, we transformed the CTX into a highly productive but flexible universal turning machine, which can work as a stand-alone or automated unit. ”

*Dr Eng. Claudio Merlo*  
Managing Director  
DMG MORI TORTONA S.R.L.



**6-SIDED COMPLETE MACHINING**

- + Left hand spindle: ISM 65 with 5,500 rpm and 171 Nm
- + Right hand spindle: ISM 50 Plus with 6,000 rpm and max. 93 Nm
- + Bar machining up to  $\varnothing 65$  mm

**HIGH ACCURACY AND RIGID MACHINE DESIGN**

- + Holistic cooling concept and direct scales by MAGNESCALE in X1, X2, Y1 and Z (optional)
- + High positioning accuracy within 6  $\mu$ m / 12 arcseconds

**HIGH MILLING PERFORMANCE**

- + Both turrets can work at both spindles individually or simultaneously
- + 100 mm Y-axis on the upper turret
- + Upper and lower turret: VDI 30 with 6,000 rpm and max. 14 Nm / 12 tool stations as standard
- + Air/oil lubrication for 100% duty cycle when milling
- + Optional high speed option with 7,000 rpm and 17 Nm
- + Optional DirectDrive turrets with 12,000 rpm and 14 Nm (upper turret only)
- + Optional DirectDrive turret with 16 tool stations VDI30



CLX 450 TC

## 6-SIDED COMPLETE MACHINING WITH B-AXIS SPINDLE

### 100% TURNING

- + Integrated spindle drive up to 5,000 rpm and 345 Nm as well as C-axis [0.001°]
- + 6-sided complete machining thanks to the main and optional counter spindle
- + Workpieces up to  $\varnothing 400 \times 1,100$  mm machined in a 7.1 m<sup>2</sup> footprint

### 100% MILLING

- + Turn-mill spindle with 12,000 rpm and 90 Nm

### 100% MORE TOOLS

- + Tool magazine with up to 60 pockets, 30 pockets as standard



You can find a video on the CLX 450 TC here: [youtu.be/rspKW7Mpw2g](https://youtu.be/rspKW7Mpw2g)

# EFFICIENT TURNING & MILLING OF TECHNICAL PLASTICS



*The CLX 450 TC is a milestone in our production: We now produce on one machine, instead of two machines with several manual reclampings. And that includes in-process measuring.*

**Klaus Ament**  
Company founder and CEO  
AMENT plastics GmbH



AMENT plastics GmbH from Wernberg-Köblitz has been producing complex precision components from technical plastics since 2005 – mostly individual parts and small series. Long-standing customers from the automotive, medical and aerospace industries rely on the know-how of the 25-strong team. Its expertise includes in particular the sophisticated machining of thermoset plastics. This accounts for a good 70 percent of day-to-day business. AMENT plastics purchased a CLX 450 TC from DMG MORI in 2022 as part of its capacity expansion and process optimization. Thanks to 6-sided complete machining, the company was able to drastically reduce throughput times, achieve higher quality and increase flexibility.

»

Compared to thermoplastics, which AMENT plastics also uses, thermosets place significantly higher demands on machining. "While the first produces normal chips, thermosetting plastics produce dust that must either be extracted or flushed away, which in turn leads to an aggressive sludge," says company founder and CEO Klaus Ament, explaining the difference between the two plastics. However, depending on the application – for example in electrical engineering – wet processing is not possible because the material then absorbs too much moisture. Thermosets are laminates made from synthetic resins. The layers consist of hard paper, cotton fabric or – since the middle of the 20<sup>th</sup> century – epoxy glass fiber. The latter in particular is considered to be very abrasive, which means that harder tools are required. "So every plastic has its own parameters, which experienced specialists have to bear in mind during production," says Klaus Ament, pointing out the importance of good personnel.

#### Future-proof production with complete machining

AMENT plastics relies on modern CNC technologies to machine the often complex geometries. 5-axis simultaneous milling and 6-sided turning & milling are now standard. Erik Fleischmann, production manager, believes that complete machining on turn-mill centers is the right way forward:



1. Klaus Ament (left), founder and CEO of AMENT plastics, and Erik Fleischmann, production manager.

2. With travels of 750 × 200 × 1,100 mm, the CLX 450 TC covers a wide range of components. With a bar loader and a container for finished parts, production can also run in unmanned night shifts.

3. The counter spindle and the compactMASTER turn-mill spindle make the CLX 450 TC a versatile machining center for one-hit production.

"The original production process involved at least two machines and repeated re-clamping. This takes much longer, ties up machine capacity and the accuracy is more variable." The investment in a CLX 450 TC was therefore a major milestone. Together

## CAPACITY EXPANSION THROUGH PROCESS INTEGRATION

with a colleague, Erik Fleischmann was responsible for the acquisition of the turn-mill center. Good experience with older turn-mill machines from GILDEMEISTER led him to DMG MORI. The choice was between the CTX beta 800 TC and the CLX 450 TC. "As space is limited, we opted for the smaller model," he recalls. "Integrating several machining processes into one work area is a good way to expand capacity."

#### Automated production with bar loader and parts removal

With travels of 750 × 200 × 1,100 mm, the CLX 450 TC covers a wide range of components. The counter spindle and the compactMASTER turn-mill spindle make it a versatile machining center for one-hit production. If required, Erik Fleischmann can also integrate in-process measurement: "Occasionally, the machine produces a series of parts. In such cases, continuous quality control in the work area saves time." A bar loader and a container for finished parts have also been installed so that these series can be produced during unmanned night shifts.

"Single-part production and our large material warehouse allow us to fulfill even urgent orders on time," says Erik Fleischmann. "The turn-mill center is an additional benefit in this respect." The company has learned from this for future investments. Another factor that speaks in favor of a high degree of process integration is the shortage of skilled staff. Despite the attractive work with technical plastics, it is a major challenge to find trainees, says Klaus Ament: "Complete machining will remain an important criterion when further machines are replaced – perhaps involving a larger CTX beta TC."

#### AMENT PLASTICS FACTS

- + Founded in Wernberg-Köblitz in 2005
- + 25 skilled staff
- + Production of complex precision components made from technical plastics, including the demanding machining of thermoset plastics



AMENT plastics GmbH  
Nürnberger Straße 139  
92533 Wernberg-Köblitz, Germany  
[www.ament-plastics.de](http://www.ament-plastics.de)



Thermosets are laminates made from synthetic resins. The layers consist of hard paper, cotton fabric or – in this case – hard epoxy glass fiber, which is very abrasive and requires harder tools.



6-sided turn-mill machining allows AMENT plastics to produce complex workpieces economically and precisely.

# CAPACITY INCREASE BY MEANS OF ROBOT AUTOMATION

WILHELM BAHMÜLLER Maschinenbau Präzisionswerkzeuge GmbH from Plüderhausen has its roots in a mechanical workshop that was established in 1945. Starting with circular shears, the company soon laid the foundation for its corrugated cardboard processing business, which is still successful today. Over the years, the range of services has been extended to include precision grinding, automation and precision tools. 400 experienced engineers now ensure that the company's processes run

smoothly, from development to production and on to sales and service. BAHMÜLLER has been manufacturing using machine tools from DMG MORI for more than 40 years and currently uses ten different models. Since 2023, the company's investments in modern manufacturing systems have included automation solutions. For example, a CTX 1250 beta TC was retrofitted with a Robo2Go in 2023. A CLX 450 TC followed later in the year, which was also equipped with user-friendly robot auto-

mation. This has put BAHMÜLLER in a position to reduce its production costs and counteract a shortage of skilled personnel.

**Design and development of precision tools**  
Its high quality and reliability standards have made BAHMÜLLER a competent partner in the manufacture of precision tools. "We fulfill all requirements for machining with our standard range of products for all of the most popular spindle connections, and also customizations," explains Hans Binder,



Small batches with short run times are manufactured on the CLX 450 TC during the day. At night and over the weekend, batch sizes of up to 30 parts and more, depending on running times, are produced without operator attendance.

CLX 450 TC WITH Robo2Go

## 6-SIDED COMPLETE MACHINING WITH B-AXIS SPINDLE

### 100% TURNING

- + Integrated spindle drive up to 5,000 rpm and 345 Nm as well as C-axis (0.001°)
- + 6-sided complete machining thanks to main spindle and optional sub-spindle
- + Workpieces up to  $\varnothing 400 \times 1,100$  mm in a 7.1 m<sup>2</sup> footprint

### 100% MILLING

- + compactMASTER Turn&Mill spindle with 12,000 rpm and 90 Nm

### 100% MORE TOOLS

- + Tool magazine with up to 60 pockets, 30 pockets as standard

### Robo2Go

- + Flexible automation solution for unattended shifts

the head of the precision tools business area. "We support our customers with an innovation-oriented team, right from the design and development stage." BAHMÜLLER safeguards the future of this team by providing plenty of training and currently has 37 apprentices.

and increase our capacity by integrating different manufacturing technologies in a single workspace, even to the extent of complete machining in an ideal case," says Hans Binder, looking back at this development. Complete machining is also regarded as an efficient way of fulfilling the increasing demands that are being made with regard to precision.

## MORE PRODUCTIVE WITH 5-AXIS SIMULTANEOUS MACHINING

BAHMÜLLER combines technical expertise with modern manufacturing solutions. Older machines are regularly replaced with technologies that are more innovative. 5-axis simultaneous milling centers such as the DMU 125 P duoBLOCK and DMU 160 P duoBLOCK have already been in use for many years, and turning-milling centers are also becoming increasingly important. "We have been able to drastically reduce our throughput times



A video of the CLX 450 TC can be found at:  
[youtu.be/rspKW7Mpw2g](https://youtu.be/rspKW7Mpw2g)



Thanks to the app-based operation of Robo2Go, it took less than a day to train an operator to use the system.



“Robo2Go is the ideal starting point for digitization. It is simple to retrofit and training takes less than a day thanks to the app-based controller.”

**Hans Binder**  
Head of Precision Tools Division  
WILHELM BAHMÜLLER Maschinenbau

#### 6-sided turn-mill complete machining

After installing two CTX beta 1250 TC turning centres, a CLX 450 TC was purchased in 2023. “The work area is of a similar size and in this case we did not need 5-axis simultaneous milling,” says Hans Binder, justifying the purchase of the entry-level model for turning and milling. “The attractive price obviously made the decision easier. The machining of workpieces, including tool bodies and milling heads, takes place from all 6 sides in a single process. The finished products only require burnishing and grinding.”

### Robo2Go: INTUITIVE OPERATION USING APP-BASED CONTROL

BAHMÜLLER took a new step towards extending capacity in 2023 with the initial automation solutions. Hans Binder sees DMG MORI as the right partner for this:

“The extensive range of automation provides a sufficient amount of choice to get started in this area.” Robo2Go is regarded as the perfect example. “DMG MORI succeeded in retrofitting the robot on the CTX beta 1250 TC very easily and the CLX 450 TC was installed as a complete, automated system.” In both cases, it only took a day to train an operator to use the app-based control of the Robo2Go. “The system is self-explanatory and intuitive, because it guides the user through the process.”

#### Low production costs thanks to unattended shifts

In practice, both Robo2Go systems integrate into the everyday working environment in an optimum way. “We produce individual parts and small batch sizes with short run times on the CLX 450 TC during the day at the same time as working on other machines,” says Hans Binder, describing the process. An additional employee is not required. “At night and over the weekend, we process bigger batches of up to 30 parts and components having longer running times completely unattended.” In this way, BAHMÜLLER has increased its capacity significantly and reduced production costs

Precision tools for all of the latest spindle connections, and also customized solutions.



at the same time. The range of components varies between  $\varnothing 20$  mm and  $\varnothing 175$  mm, which is the maximum diameter of the gripper. The load capacity of the Robo2Go including the gripper is 35 kg, which is more than enough for the relevant workpieces.

#### Safely into the future thanks to automation

BAHMÜLLER has successfully achieved entry into automated production with the two Robo2Go machines. In the light of anticipated challenges, Hans Binder is looking ahead with confidence. Automated production will be an important topic in future investments: “Both the shortage of skilled staff and the geopolitical situation will continue to be concerns in the coming years. Against this backdrop, automation solutions will be indispensable in order to remain competitive.”

#### WILHELM BAHMÜLLER FACTS

- + Established in Plüderhausen in 1945
- + 400 skilled staff
- + Many years of experience in cardboard processing, precision grinding, automation and precision tools



WILHELM BAHMÜLLER Maschinenbau  
Präzisionswerkzeuge GmbH  
Wilhelm-Bahmüller-Straße 34  
73655 Plüderhausen, Germany  
[www.bahmueller.de](http://www.bahmueller.de)



1. The grippers of the Robo2Go can handle the entire component range from  $\varnothing 25$  – 100 mm.  
2. Size 32 to 160 HSK tool holders are manufactured on the CLX 450 TC, among other components.

**WORLD  
PREMIERE  
2024**

# CLX 550 TC

## PROVEN CONCEPT – NEW SIZE

### CLX 550 TC

NOW WITH  
CELOS X ON  
SINUMERIK ONE



**3D SHOPFLOOR  
PROGRAMMING**  
→ from page 98

**OP WORKBENCH**  
→ from page 96

CLX TC series		CLX 450 TC	CLX 550 TC
Workpiece	mm	ø 400 × 1,100	ø 550 × 1,600
Y-axis	mm	± 100	± 135
Left & right* hand spindles	rpm / Nm / kW	5,000 / 345 / 17	4,000 / 720 / 32
Bar diameter	mm	ø 65	ø 102
Turn & Mill spindle	rpm / Nm / kW	12,000 / 90 / 10.5 (HSK-T63, Capto C6')	
Swivel range of B-axis	°	240	

\*option

*The success of the  
CLX 450 TC has compelled  
us to build the next size.*

Harry Junger  
Geschäftsführer  
DMG MORI Bielefeld GmbH



## MX READY FOR AUTOMATION



### 6-SIDED COMPLETE MACHINING

- + Finish machining without manual intervention
- + Equivalent left and right\* hand spindles with a torque of up to 720 Nm and 4,000 rpm for maximum flexibility
- + Increased productivity thanks to high machine availability and easy automation

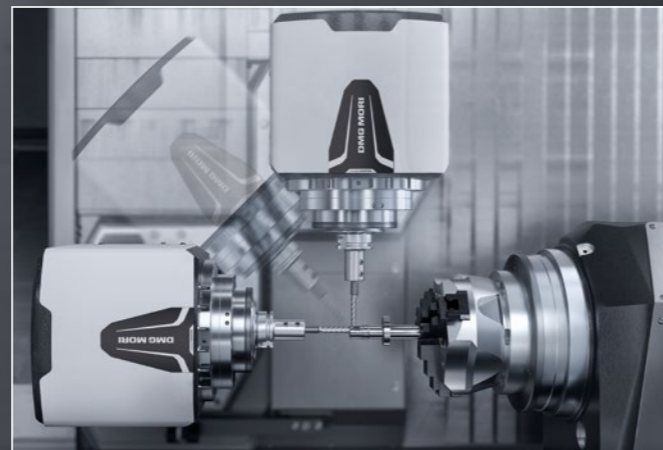

### B-AXIS FACTOR

- + The B-axis with the 90 Nm compactMASTER turning/milling spindle replaces the tool turret for full turning performance and full milling performance
- + Swivel range of the B-axis ± 120° for use at the left and right hand spindles
- + Automatic tool change, even for multitools and sister tools

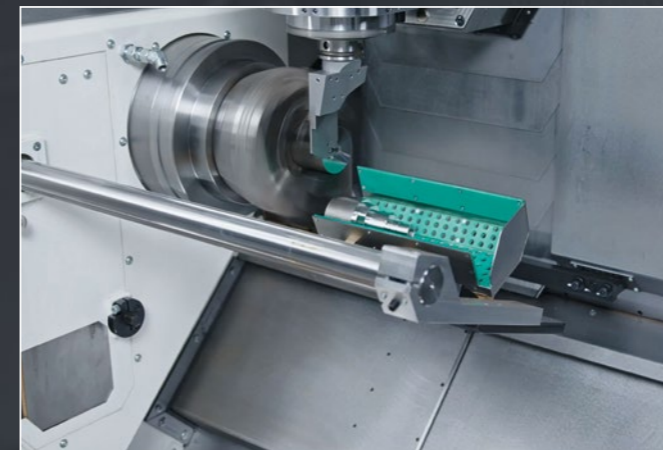

### UNLOADING DEVICE

- + For workpieces up to ø 100 × 300 mm and 12 kg as standard

### Robo2Go TURNING

- + With Vision comfort function
- + With pallet station with laser detection
- + With drawer storage



### Robo2Go MAX

- + Strongest version with 210 kg load capacity and up to 115 kg workpiece weight
- + Handling of workpieces from ø 40 to 400 mm as standard
- + Fast supply and removal of raw material and finished parts using pallets or workpiece trolleys





From left to right: **Scott Peterson**, Director Automation and Facilities  
**Sarah Sundine**, Chief Operations Officer  
**Gregg Anderson**, Applications Engineer  
**Brian DeGrote**, Manager Automation and Continuous Improvement

# PROCESS INTEGRATION FOR INCREASED FLEXIBILITY

Founded in 1968 in Monticello, Minnesota, Ultra Machining Company, with 215 highly skilled professionals, is recognized as an experienced and reliable manufacturing service provider in the medical sector as well as the aerospace industry. The range of services includes engineering with design for manufacturability (DFM) capabilities, prototyping, machining, and post processing services like polishing, bead blasting, honing, laser marking and assembly 22 DMG MORI machine tools – the first of which was installed in 1997 – form the technological backbone of production. UMC attaches great importance to efficient processes and the consistent integration of technologies. The company has been using turn & mill technology for over twenty-five years to manufacture sophisticated components on six sides in one work area. The investment

in three additional NTX 1000 2<sup>nd</sup> Generation machines in 2023 was therefore a logical step towards expanding capacity.

## Complex geometries in difficult-to-machine materials

“Whether that is lifesaving medical components, an implant to improve quality of life, or engine components to bring families together across the globe, we are utilizing DMG MORI equipment to change people’s lives,” says Sarah Sundine, COO, giving an insight into the company’s range of services and the motivation that drives her and the team. “We focus on complex, palm-sized components made from difficult-to-machine materials.” The consistently clean and bright production areas reflect the demand for first-class quality. “Sometimes our products almost resemble jewelry.” With this high aspiration,

UMC and its competent team have developed processes and installed manufacturing solutions that make it possible to accept new orders at any time – from prototypes to high volume production.

“The DMG MORI equipment we have purchased is flexible and scalable for us so that we also can be flexible and scalable for our customers,” says Scott Peterson, Director of Automation and Facilities, explaining the strong focus on machine tool technology from the innovation leader. “Machining is the largest contributor to our value stream by a significant margin. Thus, high machine uptime is crucial to be able to supply our customers on time at all times.” The experience with manufacturing technology from DMG MORI has shown that their machine tools work absolutely reliably and meet

all the requirements in terms of efficiency and productivity. The NTX series in particular has impressed UMC, as Scott Peterson states: “It continues to prove its worth in our environment. It is flexible enough to cover all segments of production and capable of producing the most challenging components.” Challenging, in this case, means both medical component and aerospace parts requiring very tight tolerances and critical finishes.

## NTX SERIES: VERSATILE TURN & MILL CENTERS FOR VERY TIGHT TOLERANCES AND CRITICAL FINISHES

### Process integration: Efficient and reliable high-end manufacturing

In particular, the increasing integration of technologies and processes in one working area contributes to flexibility and productivity in production. The NTX 1000 2<sup>nd</sup> Generation is one of the most important models in UMC’s factory and is the perfect example. “6-sided complete machining with turning and milling in a single clamping is essential for machining high-quality products competitively,” Gregg Anderson, Application

Engineer, emphasizes. In-process measurement and constant monitoring are also important factors for process reliability. “For example, sister tools are changed in good time when wear requires it.” This feature is important to UMC, since the company machines materials that rapidly degrade tools, which may go unnoticed without machinists present. UMC also benefits from the connectivity DMG MORI’s machine tools are capable of. “It allows us to collect data on total effective equipment performance for reporting and we are able to predict equipment load,” Brian Degrote, Manager of Automation and Continuous Improvement states.



NTX 1000

## COMPACT TURN & MILL MULTITASKING CENTERS FOR 6-SIDED MACHINING

- + Workpieces up to  $\varnothing 430 \times 800$  mm, 210 mm Y-axis
- + 6-sided complete machining by left hand spindle and optional right hand spindle
- + Ultra-compact turn-mill spindle compactMASTER with up to 20,000 rpm
- + 4-axis machining by 2<sup>nd</sup> tool carrier (lower turret)
- + Chain magazine for up to 76 tools
- + Wide range of automation solutions – also retrofittable



UMC benefits from the connectivity DMG MORI’s machine tools are capable of. These machines run largely unattended overnight, with remote monitoring available for supervisors to dispatch staff to address any downtime.



A video of the NTX 1000 can be found here: [youtu.be/rpzpXwMLkcs](https://youtu.be/rpzpXwMLkcs)

**Booming space side of the aerospace market**

While the medical and aerospace industries are continuing their growth, UMC has also been seeing a large increase in demand from the space side of the aerospace market. According to Scott Peterson this ties directly into UMC's recent acquisitions of DMG MORI equipment: "This machinery has proven to meet the highest standards in terms of productivity and quality. Thus, we will be able to make parts that ensure safe missions into space."

**Investment in further process integration as well as automation solutions**

Looking at its economic development, UMC continues to invest in growth. "We recently completed a 65,000 sq ft expansion, which is providing us with the opportunity to procure new equipment and restructure our original space to better serve our customers and provide scalability for the future," says Sarah Sundine. UMC also owns more land beyond what is currently built upon for future

growth. "We are dedicated to sourcing the best equipment possible to serve our customers and end users of the products we produce." As DMG MORI covers all disciplines for production – from sophisticated prototype manufacture to quality-oriented high volume production – UMC is planning to invest in the machine tool manufacturer's production technology in the future. "An NTX 500 is high on the list for discussion. Its increased capability with a Y-axis turret, larger turret tooling capacity, increased RPM, and reduced footprint are very attractive", Brian DeGrote says. Automation solutions are a clear choice for future investments as well. "With the opportunity to have it shipped with robotics (IMTR), it checks all the boxes again. The biggest decision is where and how we want to deploy automation to best serve our customers."

**ULTRA MACHINING COMPANY FACTS**

- + Family owned and professionally managed since 1968
- + Committed to invest in the growth of its people, facilities and capabilities
- + Enriching peoples' lives through manufacturing
- + ISO 13485 & AS9100 Certified

Ultra Machining Company  
500 Chelsea Road  
Monticello, MN 55362, USA  
[www.ultramc.com](http://www.ultramc.com)

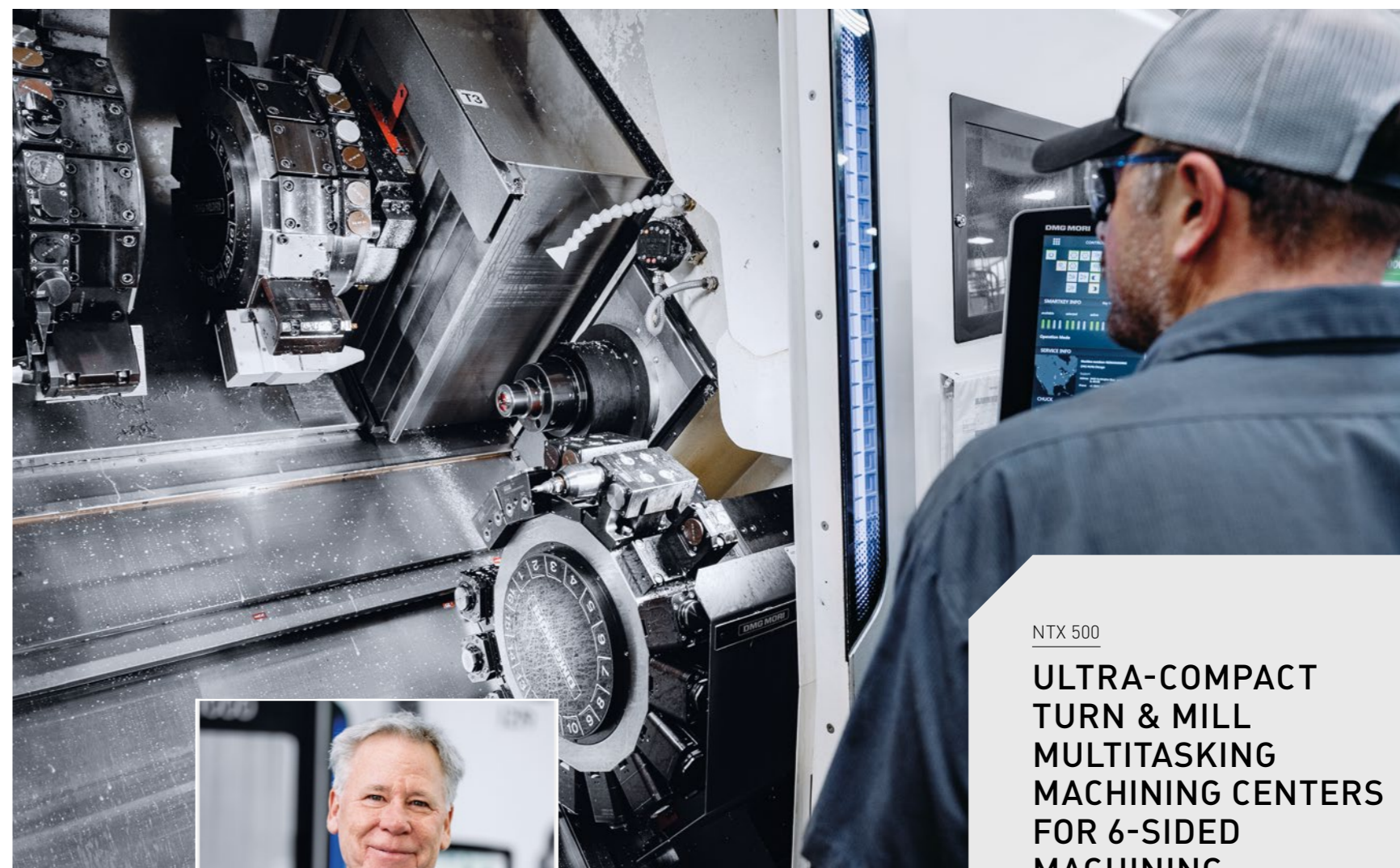

UMC also uses the NZX series with up to 3 turrets, including a Y-axis on each turret.

NTX 500

**ULTRA-COMPACT TURN & MILL MULTITASKING MACHINING CENTERS FOR 6-SIDED MACHINING**

- + Workpieces up to  $\varnothing 120 \times 558$  mm, 150 mm Y-axis
- + 6-sided complete machining by left hand spindle and optional right hand spindle
- + Ultra-compact turn-mill spindle compactMASTER with up to 42,000 rpm
- + 4-axis machining by 2<sup>nd</sup> tool carrier (lower turret)
- + Chain magazine for up to 114 tools
- + Wide range of automation solutions, e.g. the IMTR:
  - Loading and unloading by robot
  - Robot max. transfer weight: 7 kg (max. weight of workpiece per hand: 2 kg)
  - max. workpiece diameter:  $\varnothing 70$  mm
  - max. workpiece length: 65 mm

*The DMG MORI Turn & Mill machines of the NTX series enable us to produce highly complex and demanding parts for our customers. They do so with absolute reliability and meet all requirements in terms of efficiency and productivity.*

**Scott Peterson**  
Director of Automation and Facilities  
Ultra Machining Company



A video of the NTX 500 can be found here:  
[youtu.be/4o1mHBGALL4](https://youtu.be/4o1mHBGALL4)

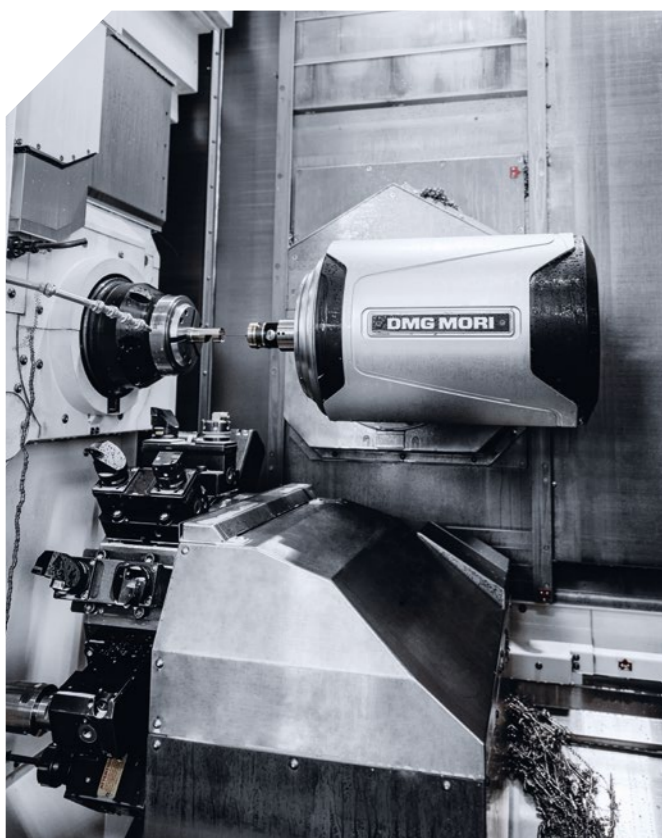

6-sided complete machining with turning and milling in a single clamping is essential for machining high-quality products competitively.



Materials rapidly degrade tools, which may go unnoticed if machinists are not present. Utilizing the tool life management system for lifecycle monitoring and sister tool exchange maximizes unattended process reliability.



# UNMANNED PRODUCTION & DOUBLE CAPACITY

Sandvik Coromant entered into a partnership with Teenees from Trondheim in 1970 to produce so-called Silent Tools. Equipped with a damping system, the unique range of tools and adapters minimizes vibration, even with a long tool overhang. Sandvik Coromant took over the partner in 2008 and has continuously developed this product division. With 105 specialists and modern machine tools, the tool manufacturer ensures that customers from all over the world and all industries receive first-class solutions, from standard products to special developments. Since 2001, Sandvik Coromant Trondheim has often relied on automated CNC technology from DMG MORI. After the initial use of gantry solutions, DMG MORI installed an NZX 1500 with robot handling for the first time in 2020. This was followed in 2023 by an automated NTX 3000. The manufacturing solution enables highly flexible production of a wide variety of CAPTO tool bodies.

## PRECISION TOOLS WITH INTEGRATED DAMPING SYSTEM

“We manufacture 450 standard products in Trondheim and ten percent of our business is customer-specific tool solutions,” says Steinar Løkken, Manager Technical Operations at Sandvik Coromant Trondheim, about the scope of production. Silent tools are a core business. Inside these turning, milling and drilling tools is a preset damping system consisting of a heavy damping body supported by two springs. When vibration occurs, the kinetic energy is absorbed by the damping system. This minimizes the vibration, improves surface quality and increases productivity.

»

The automated NTX 3000 processes up to 150 components and ensures sufficient production capacity over four unattended shifts.

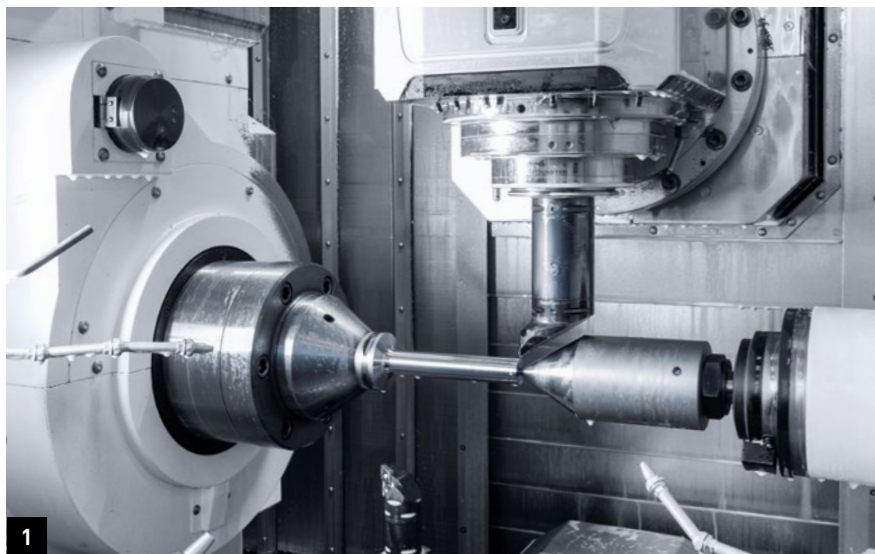

1. Thanks to the large working area of the NTX 3000, Sandvik Coromant Trondheim can easily machine tool bodies with diameters from  $\varnothing 16$  mm to  $\varnothing 80$  mm. 2. Sandvik uses in-process measurement for each workpiece. Post-process measurement outside the machine is thus reduced to occasional spot checks.

stations, each of which can accommodate a Euro pallet with pre-machined blanks and simultaneously deposit the finished parts. The robot removes the raw parts with a magnetic gripper, repositions them and removes a protective cap. Each part is then

## WE CAN LOAD THE SYSTEM WITH 150 BLANKS OF DIFFERENT SIZES

### Competitive for over 20 years thanks to automation solutions

Sandvik Coromant works continuously on improving cost efficiency. Manufacturing of the high-quality tools is no exception, explains Steinar Løkken: "That's why we have been using automated manufacturing solutions for over 20 years." Norway is a typical high-cost country, where automation really pays off. "Gantry systems and robots increase component quality because manual handling is no longer necessary." In view of the small to medium batch sizes and a large number of product variants, flexibility in production is another challenge. For Kristoffer Bjørnstad, Process Development Engineer at Sandvik Coromant Trondheim, robot solutions therefore play a major role.

"The NZX 1500 has convinced us to continue along this path." The automation solution is loaded with raw parts via a conveyor. The robot recognizes the position using a camera and takes over loading and unloading of the machine.

### NTX 3000 with customized automation solution

With the automation solution based around the NTX 3000, Sandvik Coromant Trondheim has reached a new level of unattended production. "Our aim was to double our capacity and at the same time machine a wide range of CAPTO tool bodies," says Steinar Løkken, recalling the start of the concept. DMG MORI was able to implement all the requirements. The system has three loading

cleaned in a washing machine before being centered in another station. The robot uses one of four different grippers to load and unload the tool bodies – Capto C3 and C4, C5 and C6, C8 or a magnetic gripper for handling the blanks. In addition, a vacuum gripper is used to remove the wooden intermediate bases from the pallets of blanks.

### Doubling the production capacity

"Handling is always fast enough that the next tool body can be inserted seamlessly after machining," explains Kristoffer Bjørnstad. "We can run up to 150 parts of different sizes without human interaction, which enables high-capacity utilization with processing times of up to 15 minutes. It runs up to four shifts – unattended, with double the output."



The automated NTX 3000 processes up to 150 components and ensures sufficient production capacity over four unattended shifts.



### Process integration: Precise turn & mill machining including in-process measuring

Thanks to the large work area of the NTX 3000, Sandvik Coromant Trondheim can easily machine tool bodies with diameters from  $\varnothing 16$  mm to  $\varnothing 80$  mm. The longest tool bodies reach 561 mm. A tailstock and a steady rest in the lower turret provide the necessary stability, while the simultaneous use of tools in the lower turret and the milling spindle contributes to high productivity. Thanks to the turn & mill spindle, complete machining is carried out on just one machine.

*The automated NTX 3000 enables us to manufacture tool bodies to high precision to within tens of microns – thanks to the integration of turning, milling and in-process measuring on one machine.*

*Kristoffer Bjørnstad, Process Development Engineer (left)  
Steinar Løkken, Manager Technical Operations (right)  
Sandvik Coromant Trondheim*



NTX 3000

## BEST IN CLASS

- + **Turn & Mill – 6-sided complete machining** of workpieces up to  $\varnothing 670 \times 1,538$  mm
- + **turnMASTER** turning spindle: 8" chuck, 5,000 rpm, max. 421 Nm
- + **compactMASTER** Turn & Mill: Spindle with 132 Nm torque and 350 mm in length
- + **Multitasking:** DirectDrive B-axis for 5-axis simultaneous machining of complex workpieces
- + **High degree of flexibility** due to X-axis travel up to -125 mm below the spindle centerline
- + **12-station BMT turret** with 12,000 rpm and 80 mm Y-axis
- + CELOS with MAPPS on FANUC and CELOS with SIEMENS available



You can find a video of the NTX 3000 2<sup>nd</sup> Generation at: [youtu.be/aUrrM9Z000Y](https://youtu.be/aUrrM9Z000Y)

DMG MORI has also implemented the integration of in-process measuring. The accuracy of the machined tool bodies is to within tens of microns and is a prerequisite for the assembly of the damping systems. "We use in-process measurement to check every workpiece," says Kristoffer Bjørnstad. "This reduces the need for measurement outside the machine to occasional spot checks." In-process measurement can also be used to feed back offsets automatically to the machine control.

### Long-standing partnership with DMG MORI as a win-win situation

"Automation solutions like these help us to work more economically and remain comp-

etitive," summarizes Steinar Løkken. They are also a means of becoming more sustainable. Sandvik is pursuing ambitious goals. "Our aim is to manufacture as resource-efficiently as possible and to utilize our production capacity as efficiently as possible, and DMG MORI supports us in this." He sees the long-standing cooperation with the machine tool manufacturer as profitable for both sides, because such complex manufacturing solutions always involve learning: "We would like to benefit from this when investing in new automation solutions in the future."



The system has three loading stations, each of which can accommodate a Euro pallet with pre-machined blanks, while the finished parts are deposited at the same time.



1. For loading and unloading tool bodies, the robot uses one of four different grippers – Capto C3 and C4, C5 and C6, C8 or a magnetic gripper for handling blanks.
2. Handling is sufficiently fast at all times that after one tool body has been machined the next one can be exchanged seamlessly.
3. The robot removes raw parts with a magnetic gripper and repositions them to remove a protective cap. Each part is then cleaned in a washing station before it is centered in another station.

### SANDVIK COROMANT TRONDHEIM FACTS

- + After decades of close partnership, Sandvik Coromant took over the former Teenees, based in Trondheim
- + 105 experienced specialists
- + Development and production of tools with damping system

### SANDVIK Coromant

Sandvik Coromant Trondheim  
Ranheimsvegen 127  
7053 Trondheim, Norway  
[www.sandvik.coromant.com](http://www.sandvik.coromant.com)





# HIGH SPARE PART AVAILABILITY THANKS TO AUTOMATED PRODUCTION

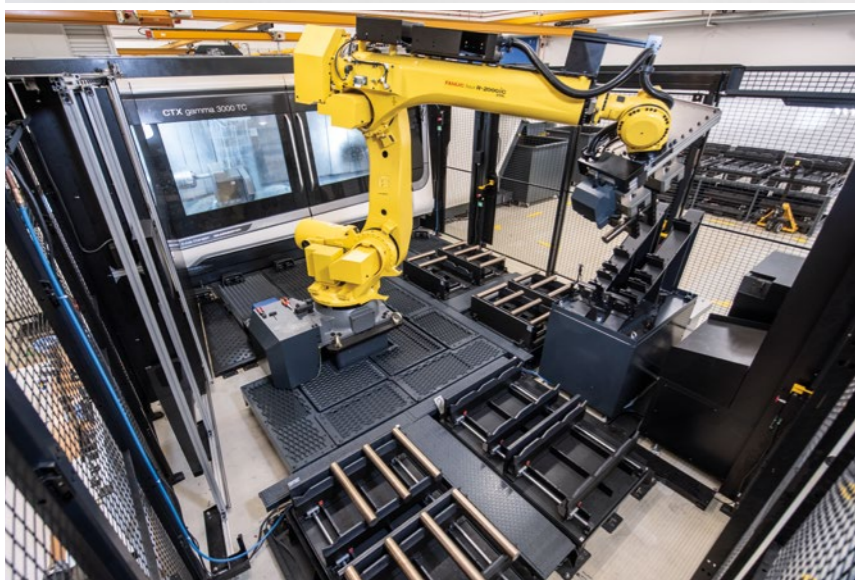

The CTX gamma 3000 TC, automated with MATRIS, produces high-precision spindles.

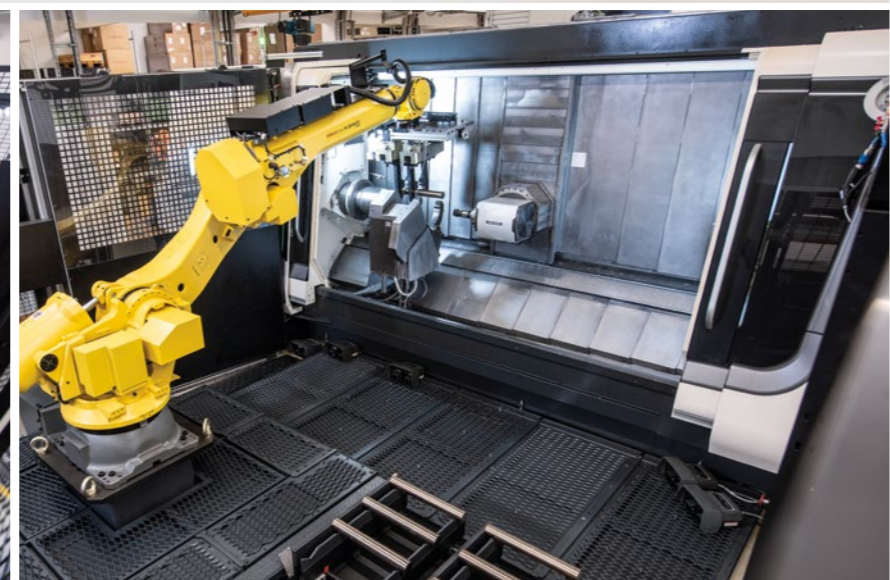

The production process includes 6-sided complete machining, deep hole drilling, grinding and in-process measuring.



What began in 1893 at GEA's Oelde site, with the construction of the first manually operated centrifuge for separating milk and cream, is now an indispensable part of modern industry. Whether food, beverages, pharmaceuticals and vaccines, chemical and marine products or clean water: anywhere liquids have to be processed, a separator or a decanter is at the heart of the production plant. Today, Oelde is GEA's largest production site worldwide with a total of 1,900 employees. Up to 120 centrifugal separators are produced here every month, from development to final acceptance. The centrifuge manufacturer ensures high productivity and quality with equally modern machine tools, including 15 models from DMG MORI – from 5-axis simultaneous machining centers to turn-mill centers with maximum process integration. The latest acquisition fits perfectly into the future-oriented production: on a CTX gamma 3000 TC with MATRIS robot, the drive production department produces spindles in a wide range of variations – including deep hole drilling, grinding and in-process measuring.

Up to 500 components are required to manufacture one of the complex centrifugal separators, from the drive to the bowl and its inner workings. "As the components to be manufactured are adapted to the customer's application, many components are produced in a batch size of 1; after all, we are in the special machine building business," says Dennis Hartmann, Head of Industrial Engineering in the Separators Business Unit, giving us an idea of the production effort involved.

Consistent process optimization enables cost-efficient production in the traditional plant. The largest and most modern hall in Oelde has an automatic storage and transport system with 5,000 pallet stations. The individual components are brought together in an efficiently synchronized flow assembly. After assembly, all separators undergo practical testing on 16 test benches. "Another important part of our daily work is supplying our customers with spare parts," explains Dennis Hartmann. GEA's more than 50 sales

## FLEXIBLE & AUTOMATED COMPLETE MACHINING OF COMPONENTS WITH A BATCH SIZE OF 1

and service companies regularly determine their requirements and commission the plant to produce the parts needed. This also applies to drive products – including gear and belt drives as well as (in the most modern version) integrated direct drives. "We manufacture the corresponding components in batch sizes of up to 50 parts." In addition to turning and milling, machining of the complex and high-precision spindles includes deep hole drilling and grinding, as well as gear milling for some variants.

With the high degree of process integration from turn-mill to in-process measuring as well as the automation solution from a single source, DMG MORI's offer was absolutely convincing.

**Dennis Hartmann**  
Head of Industrial Engineering  
Separators Business Unit  
GEA Westfalia Separator

#### Future-oriented focus in production

"We implemented our philosophy of integrating as many processes as possible and automating spindle production in 2023," says Dennis Hartmann, looking back on the purchase of a CTX gamma 3000 TC with a MATRIS robot. Following positive experiences with previously installed machine tools from DMG MORI, those responsible in Oelde once again found what they were looking for in the market leader's product range. "The high degree of technology integration and the automation solution from a single source were the deciding factors in the market comparison." Test runs were also convincing and the proximity to the DMG MORI factory in Bielefeld was a major advantage during the project. There is another point that stands out: from process integration and automation to digitalized processes and sustainable management, GEA is pursuing exactly what DMG MORI is also aiming for with its Machining Transformation (MX) – a future-oriented approach to the entire production process.

#### 6-axis turning-milling, deep hole drilling, grinding and in-process measuring

With the automated CTX gamma 3000 TC, GEA has firstly replaced an old machine and secondly made spindle production significantly more cost-effective. "Previously, machining processes were required on milling machines, turning centers and a cylindrical grinding machine. Then there were the idle times in between," explains Marcel Richter. As machine operators, he and Patrick Wieder are responsible for operating the production cell. Their practical experience was incorporated into the CTX design. The turn-mill center for 6-axis complete machining integrates all the different processes, including grinding, in one work area. "The result is significantly shorter throughput times. And we can make better use of the other machines at the same time," says a satisfied Patrick Wieder. The in-process measurement also makes life easier for quality control. Deviations are corrected in the program so that the values remain consistent throughout the batch. "We can even determine tool wear automatically using a measuring fixture. If the actual value exceeds the target value, the tool is replaced by a sister tool."

#### Optimum equipment for process reliability and flexible automation

The CTX gamma 3000 TC was selected to enable reliable and flexible machining. "The size was necessary because we machine spindles that are up to 1,000 mm long. We need sufficient travel in the X-axis for deep hole drilling," says Patrick Wieder, explaining the choice of model. A powerful coolant pump prevents the accumulation of chips that would interrupt the process. Another special feature is a separate compartment for oversized tools in the right-hand section of the work area. "This allows us to carry out the grinding process with larger wheels, for example, which saves time and reduces tool costs," explains Marcel Richter. The biggest advantage is, of course, the fully automated production of entire batches. The MATRIS system was designed to be loaded via four pallets. The robot takes the raw parts and aligns them so that it can clamp them correctly in the chuck and steady rest. The finished parts are then placed back on the pallet. The close cooperation with DMG MORI

"A split screen shows the executed operations on the left and the corresponding G-code on the right, while a live view of the operations being performed at the main or counter spindles further enhances the understanding of the programs."

#### Solution-oriented collaboration throughout the entire project

Process optimization in Oelde is a continuous process that will also be the central issue for future new acquisitions in the factory. "Whether as a replacement for old machines or as part of technology integration – our investments in production are always driven by innovation," says Dennis Hartmann, explaining the motivation behind new acquisitions. "A solution-oriented partner like DMG MORI is a great support, especially for large projects that can extend over a period of up to two years, as in the case of the CTX gamma 3000 TC."

## SIMPLE WORKSHOP-ORIENTED PROGRAMMING WITH OP WORKBENCH

was also evident where programming is concerned. With the installation of the CTX gamma 3000 TC, GEA was also a pilot customer at the Oelde site as part of the development of OP Workbench. "The software significantly simplifies the work involved in workshop-oriented programming," says Marcel Richter, assessing the added value in terms of time. "OP Workbench uses master programs to which we add set-up parameters such as the length of the chuck. Machining sequences are placed in the right place in the program using drag & drop." The resulting operation sequence is sent to the NC, where the user enters the G-codes to produce the workpiece. Patrick Wieder also sees an advantage in the display:

#### GEA WESTFALIA SEPARATOR FACTS

- + Since 1893 the leading producer centrifugal separators
- + Centrifuges for several industries, whether food, beverages, pharmaceuticals and vaccines, chemical and marine products or clean water
- + With more than 18,000 employees, GEA Westfalia Separator is part of the international GEA Group



GEA Westfalia Separator Group GmbH  
Werner-Habig-Straße 1  
59302 Oelde, Germany  
[www.gea.com/separation](http://www.gea.com/separation)

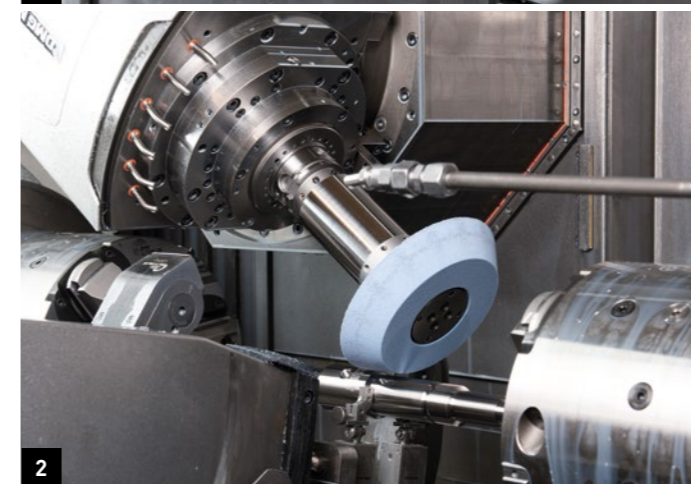

1. The size of the CTX gamma 3000 TC was necessary to machine spindles that are up to 1,000 mm long, as sufficient travel in the X-axis for deep hole drilling is needed.
2. The turn-mill center for 6-axis complete machining integrates all the different processes, including grinding, in one work area.
3. In-process measuring of surface quality.
4. Separate compartment for oversized tools in the work area, enabling grinding with larger wheels to save time and reduce tool costs.

# OPENING UP NEW MARKETS WITH PROCESS OPTIMIZATION

GRANDE-TEK Flow Control Co, Ltd. was founded in Hebei, China as a national high-tech company in 1996. The company specializes in the development and manufacture of flow control systems and valves. Its sales organization is export-oriented. Formerly, up to 90 percent of sales were generated in Europe, the USA, Japan and other parts of the world. In recent years, however, manufacturing industry in China has grown rapidly, to the extent that the domestic business of GRANDE-TEK Flow Control now accounts for 50 percent of its sales. This development has led to numerous investments in manufacturing technologies. DMG MORI has been a regular partner since 2021 and has already installed various 5-axis milling and mill & turn machines, such

as the DMU 125 FD duoBLOCK and versatile turning centers such as the NLX 2000 and the CTX beta 1250 TC turn & mill machine. When it comes to machining, GRANDE-TEK Flow Control has opted for DMG MORI. With the most recently acquired VERTICAL MATE 85 for grinding, there are now eight machine tools from the innovation leader on the factory floor.

## Process integration mill & turn and turn & mill

"With strong growth in domestic trade and the opening up of high-end markets, the demands on product quality are also increasing", is how Feng Junliang, Deputy Managing Director of GRANDE-TEK Flow Control, assesses the business development

and the impact on production. "Our challenge is therefore to meet the expectations of our customers. We are continuously optimizing our manufacturing processes to achieve higher accuracy and produce the demanding workpieces more efficiently."

## CNC TECHNOLOGY FOR HIGH-END MARKETS

Only cost-effective production will ensure we remain competitive in the long term in a fiercely-contested growth market. He is

well aware of the importance of modern production technology in this context: "The manufacture of valves stands and falls by efficient and reliable machine tools. Here we rely in particular on DMG MORI mill & turn and turn & mill machines."

In 2021, GRANDE-TEK Flow Control found a competent and experienced partner in DMG MORI, whose CNC technology provides consistent precision and maximum reliability. Holistically sophisticated manufacturing processes are an essential part of the supplier's portfolio.



DMU 125 FD duoBLOCK

## 5-AXIS MILL-TURN COMPLETE MACHINING

- + Workpieces up to  $\varnothing 1,250 \times 1,600$  mm and 2,600 kg
- + powerMASTER spindles with up to 12,000 rpm and 430 Nm, 5X torqueMASTER spindles with 1,800 Nm
- + Maximum rigidity for excellent machining performance
- + Integrated cooling for maximum long-term precision
- + 5 in 1 process integration: 5-axis milling, turning, grinding, gear cutting and in-process measurement
- + Versatile automation solutions – also retrofittable



A video of the DMU 125 FD duoBLOCK can be found here: [youtu.be/D1vA\\_30SjJg](https://youtu.be/D1vA_30SjJg)



GRANDE-TEK Flow Control Co., Ltd. specializes in the development and manufacture of flow control systems and valves. Two NLX 2000|500 centers and a CTX beta 1250 TC are among the machines used for turning and turn-milling.

GRANDE-TEK has two DMU 75 monoBLOCK machines and one DMU 125 FD duoBLOCK for milling and mill-turning.



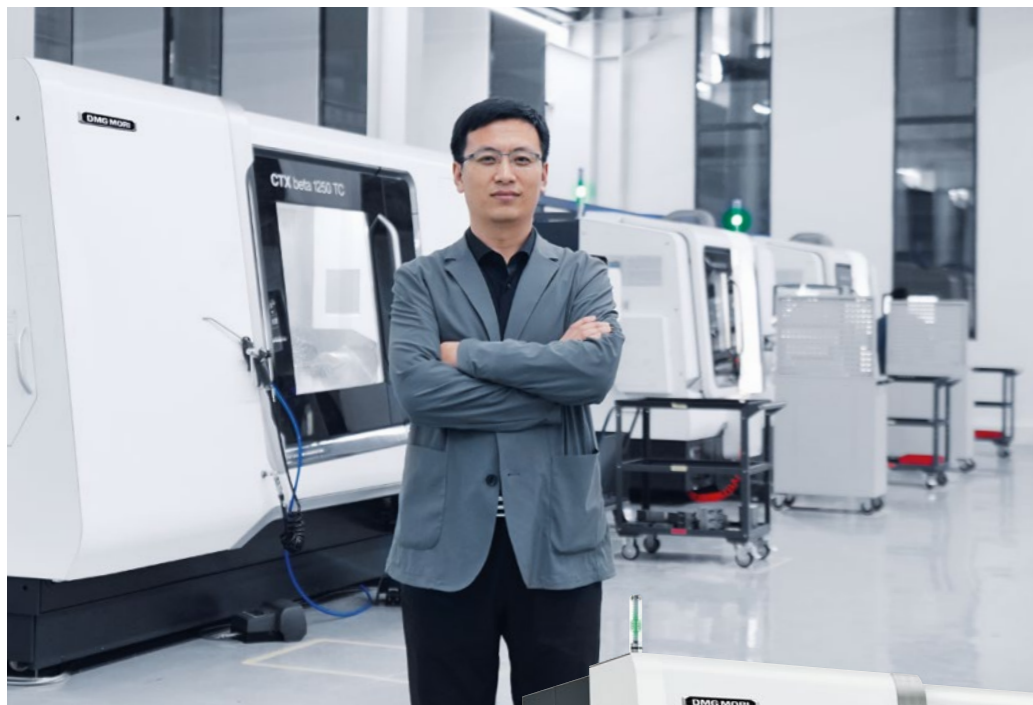

“Thanks to the mill-turn and turn-mill machines from DMG MORI, we have been able to reduce machining time by 20 percent and improve accuracy from 0.03 to 0.01 mm.”

**Feng Junliang**  
Deputy Managing Director  
GRANDE-TEK Flow Control



CTX beta 1250 TC

## TURN & MILL COMPLETE MACHINING CENTER

- + Workpieces up to  $\varnothing 500 \times 1,200$  mm, 250 mm Y-axis
- + 6-sided complete machining thanks to the main and optional counter spindle
- + Ultra compact and patented turn-mill spindle compactMASTER up to 20,000 rpm and 120 Nm
- + Tool storage as disk or chain magazine for up to 80 tools
- + 5 in 1 process integration: 5-axis milling, turning, grinding, gear cutting and in-process measurement
- + Versatile automation solutions – also retrofittable



You can find a video on the CTX beta 1250 TC here:  
[youtu.be/VeJ0nr\\_-KA0](https://youtu.be/VeJ0nr_-KA0)



For Feng Junliang these are decisive criteria, because after 20 years of experience in flow control technology, GRANDE-TEK Flow Control is well aware of these factors: “That is why we attach great importance to consistent technological innovation and investment in profitable production technologies.” Particularly during the unstable economic situation in recent years, GRANDE-TEK Flow Control took the opportunity to expand its know-how in manufacturing technology – with the help of DMG MORI.

### Machine tools for every application: 5-axis simultaneous milling, 6-sided turn-milling and grinding

Feng Junliang sees a decisive characteristic of DMG MORI in its focus on advanced manufacturing concepts: “Like no other, the machine tool manufacturer combines innovative and efficient machining technologies with a sustainable direction of travel.” Added to this is the trouble-free and friendly cooperation. This is reflected in the machine tools that have been installed since 2021: it started with the 5-axis simultaneous machining centers DMU 95 monoBLOCK and DMU 75 monoBLOCK plus the NHC 6300 horizontal machining center and the NLX 2000 turning center. Another 5-axis mill-turn center and a vertical machining

center followed in 2022 with the DMU 125 FD duoBLOCK and the NVX 5100. A CTX beta 1250 TC was also installed for 6-sided complete machining. In 2023, GRANDE-TEK Flow Control expanded the wide range of machines to include a VERTICAL MATE 85 for grinding. Feng Junliang is impressed by the easy operation of the machines and adds: “At present, the finishing of all our parts is carried out on DMG MORI machine tools.”

### Process integration: 20 percent higher machining efficiency and 50 percent more good parts

Thanks to its versatile production machinery, GRANDE-TEK Flow Control today integrates all key machining technologies in the smallest of spaces – sometimes even in one working area, as the example of the CTX beta 1250 TC shows. This enables the high-precision and efficient production of a wide range of components. “Using the example of the GPF valve, the processing time was reduced by 20 percent, the part accuracy was improved from 0.03 mm to between 0.01 and 0.02 mm and the number of good parts was increased by 50 percent,” says Feng Junliang, summarizing the optimization process. “I believe that this is closely linked to the performance of machine tools and process integration.” Process integration means combining machine tools, technologies, users, automation and digitization. This involves improving the integration of machining technologies, significantly reducing their complexity and making the right decisions. The time for production planning must be effectively shortened.

At the same time, flexibility, capacity utilization and effectiveness must be increased. Feng Junliang sees these goals as achieved: “Thanks to the process integration with machine tools from DMG MORI, the production of GPF valves can be completed in a single clamping instead of the several operations previously required. Production is faster, the accuracy of the parts is higher and the yield is significantly improved by the reduction in the number of setups.”

## WIN-WIN PARTNERSHIP FOR FUTURE-ORIENTED PRODUCTION

GRANDE-TEK Flow Control and DMG MORI have a common philosophy: The aim is to enable customers to work more efficiently and conserve resources with innovative and holistic concepts. “It is a win-win situation. We are confident that we will continue our cooperation,” says Feng Junliang. “We are also interested in future-oriented manufacturing solutions such as automated production lines and digital management systems, as well as the ULTRASONIC and LASERTEC machines.”

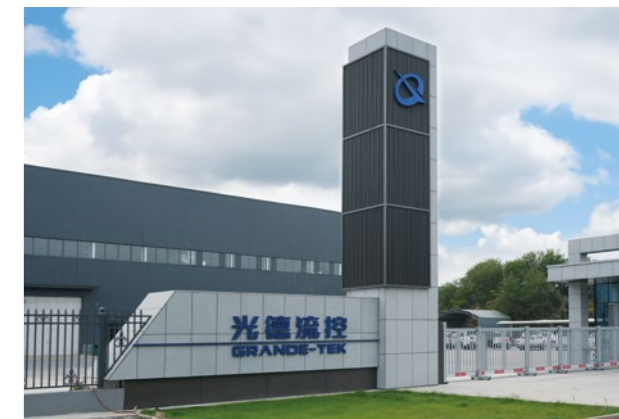

The location of GRANDE-TEK in Hebei, China



GRANDE-TEK manufactures high-precision parts and components for valves and flow control systems.

### GRANDE-TEK FACTS

- + Founded in Hebei, China in the 1996.
- + Specializes in the development and manufacture of flow control systems and valves
- + Supply split equally between domestic and international customers



Industrial Zone of Yunhe District,  
Fuyang Road, Cangzhou,  
Hebei, China  
[www.grandetekvalve.com](http://www.grandetekvalve.com)



**WORLD  
PREMIERES  
2024**

# DMV 60 | DMV 110 VERTICAL MILLING REDEFINED!



COMPACT 6.2 m<sup>2</sup>  
FOOTPRINT

COMPACT 7.6 m<sup>2</sup>  
FOOTPRINT

**HIGHLIGHTS**

- + High rigidity thanks to **improved monolithic machine bed & massive castings**
- + Process integration of **5 axis simultaneous machining** thanks to 4<sup>th</sup> / 5<sup>th</sup> axis table
- + Maximum table **load up to 1,700 kg!** (+70% compared to predecessor)
- + Improved thermal stability & excellent performance thanks to **rapid traverse of 42 m/min** in all linear axes (+40% compared to predecessor)
- + High cutting performance with optional **speedMASTER spindle up to 20,000 rpm**
- + **Linear scales in X, Y & Z axes as standard** and **direct drive transmission in X & Y axis**
- + **24" ERGOline X** multi touch control panel with **CELOS X** with **SINUMERIK 840D** or **HEIDENHAIN TNC**
- + Lower energy consumption **up to 10%** [compared to predecessor]

speedMASTER  
SPINDLES UP TO  
**20,000 rpm**  
(OPTION)



**CELOS X**

Working area		DMV 60	DMV 110
Travel in X/Y/Z – axis	mm	600/600/510	1,100/600/510
Table size	mm	900×600	1,400×600
Max. workpiece weight	kg	1,000	1,700
Max. workpiece size	mm	600×600×500	1,100×600×500

## READY FOR AUTOMATION

**DMV 110 with PH Cell 300**  
Raise your production to a higher level with a modular pallet handling system for up to 40 pallets

**DMV 60 with PH 150**  
Universal & easy to operate pallet handling system perfectly suited to your needs

**DMV 60 with Robo2Go Milling**  
Boost your productivity with a flexible workpiece handling system for small to medium batch sizes



“  
The automation systems available for the new DMV 60 and DMV 110 machines offer significant advantages in terms of flexibility and efficiency, making these machines an excellent choice for a wide range of industrial applications.”

MSc Eng. Mariusz Derbich  
Managing Director  
DMG MORI Poland

## PERFECTLY SUITED TO DIE AND MOLD MAKING

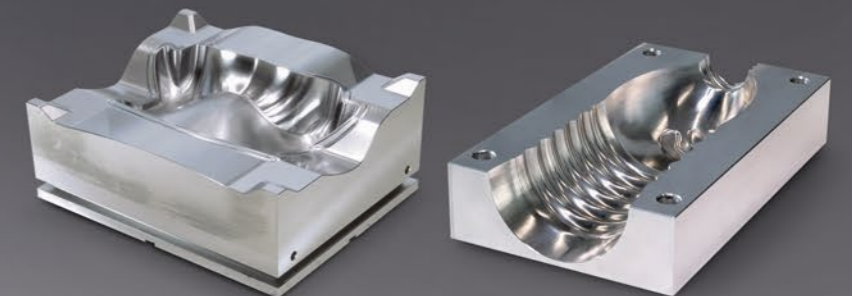

**MOLD MAKING**  
Material: 40CrMnMo8-6-4  
Dimensions: 500 × 400 × 350 mm

**BOTTLE MOLD**  
Material: AlCu4PbMg  
Dimensions: 200 × 120 × 50 mm



# RESOURCE- PRESERVING PRODUCTION BY MEANS OF ROBOT HANDLING

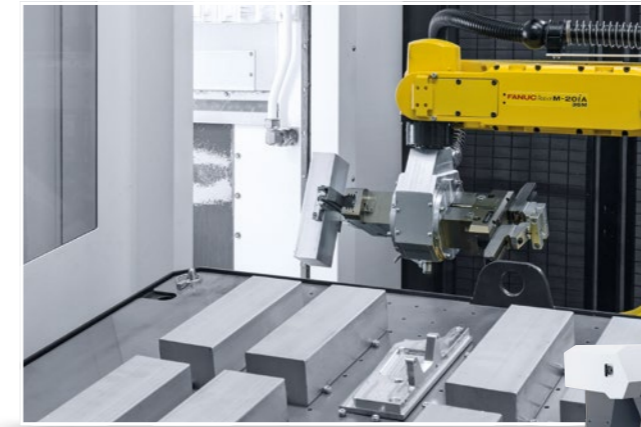

Two DMU 50 machines are automated at Mechanik-Moduls, each with a Robo2Go Milling. The Robo2Go has a load capacity of 35 kg.



DMU 50 WITH Robo2Go

## WORKPIECE HANDLING WITH A LOAD CAPACITY OF 35 kg

### DMU 50

- + 5-axis machining of workpieces measuring up to  $\phi 630 \times 600$  mm and weighing up to 300 kg
- + speedMASTER spindles up to 20,000 rpm or 200 Nm

### Robo2Go Milling

- + Flexible gripper system for workpieces measuring up to  $200 \times 200 \times 200$  mm, with robots having a load capacity of 25 or 35 kg
- + Workpiece capacity up to 500 kg
- + Full access to the machine is retained
- + An app for uniform control of all Robo2Go variants
  - Conversational programming without knowledge of robots
  - Process is created using predefined program blocks via drag & drop

Mechanik-Moduls GmbH from Forstinning-Moos near Munich has been involved in the machining of high-precision workpieces since 1990 – from prototype to large-scale production. Among others, customers in the medical, semiconductor and aerospace sectors have put their trust in the quality-oriented work of the 20 specialist employees. In addition to 3D printing and component assembly, the range of services provided by Mechanik-Moduls primarily includes CNC milling and turning. As a result of regular investments in modern cutting technologies, the company is now using five machine tools from DMG MORI, which are mainly automated. The company's most recent purchases include two DMU 50s with Robo2Go Milling, which Mechanik-Moduls financed through DMG MORI Finance as a rental purchase because of the attractive conditions that were available.

### Consistent quality and process optimization using automation

"As a manufacturing service provider, we are faced with the challenge of providing consistent quality and reacting flexibly to the respective order situation," explains Daniel Thoma, who manages Mechanik-Moduls together with his brother Dominik. The young team impresses with its technical expertise, which is incorporated during the development of new customer components, as Dominik Thoma explains: "With prototypes and in the

optimization of existing components, well-thought-out machining processes help to speed up production and make them more economical." The machine tool automation plays an important part in this process optimization. Mechanik-Moduls installed the first automated

## AUTOMATION SOLUTION FROM DMG MORI FOR OPTIMUM CAPACITY UTILIZATION

DMG MORI machines in 2017: a SPRINT 32|8 with a bar loader and a MILLTAP 700 with integrated WH 3 for autonomous workpiece handling. "Both of the machines are used to produce recurring series," says Daniel Thoma. "The automation solutions allow us to work to our full capacity, even during unmanned night shifts." The employees themselves only work single shifts. It was obvious to the two managing directors that future purchases would also have to be automated. A DMU 50 with Robo2Go Milling therefore followed in 2021.



A video about the DMU 50 with Robo2Go can be found at: [youtu.be/BH-T0PaF9ME](https://youtu.be/BH-T0PaF9ME)

»

“Our two MILLTAP 700 systems have proven that 5-axis machining is crucial for productivity,” says Dominik Thoma, assessing the investments. The DMU 50 was a logical step, adds Daniel Thoma. “The 5-axis simultaneous machining center is more stable, which allows us to perform machining that is more efficient and precise.” The compact design including Robo2Go Milling has also made it possible to extend the tool magazine to 60 locations. “This is more than sufficient, particularly for automated operation.” The Machine Protection Control 2.0 technology cycle, for example, is equally as valuable in autonomous manufacturing. “In this way, we can avoid collisions and tool breakage in an absolutely reliable way.” Consistent use is made of these and other digitalization features in order to optimize processes even further. “myDMG MORI is a good example, since it speeds up our service requests significantly and makes them completely transparent,” says Daniel Thoma.

**Fast and flexible order planning thanks to Robo2Go Milling**

DMG MORI has been trying out Robo2Go for several years – initially as Robo2Go Turning on lathes. “The Robo2Go Milling for machining centers was brand new when we placed the order,” recalls Dominik Thoma. It is said to have been the first of its kind in Bavaria. The compact automation solution was an exact fit for the part of the

building which was intended for this purpose, since when it has mainly machined workpieces for the medical sector. “There are two versions of component that Robo2Go Milling handles from a magazine,” says Dominik Thoma, describing the process. However, other orders can also be integrated quickly and flexibly. Daniel Thoma sees a clear advantage here: “Because we often have to react at short notice to fulfill delivery

**5-AXIS MACHINING AND DIGITALIZATION AS A PRODUCTIVITY FACTOR**

deadlines.” Impressed with the DMU 50 with Robo2Go Milling, Mechanik-Moduls purchased a second, identical solution in 2023 to increase its capacity. Dominik Thoma is satisfied with the decision: “This allows us to machine the rear of the medical components at the same time.”

**Convenient rental purchase with the support of DMG MORI Finance**

Mechanik-Moduls has made repeated investments in machine tool equipment from DMG MORI with the support of DMG MORI

Finance right from the beginning. “This makes us more independent of our main bank and the conditions are comparable,” says Dominik Thoma, explaining the financing. DMG MORI Finance provides leasing, rental or hire-purchase – the latter was chosen by Mechanik-Moduls – and provides the possibility of reduced initial installments in order to preserve liquidity. This allows the machine to generate additional profit early on. Annual fee-free special repayments are also possible.

**Future-proof modernization of the machinery**

Because of the company’s positive experience with automated machine tools from DMG MORI and the financing options, Mechanik-Moduls would like to keep the good cooperation going. As soon as older machines need to be replaced, DMG MORI’s wide range of products will be examined for future-proof manufacturing solutions. Daniel Thoma is already looking ahead: “Automation solutions will be an important component, because they will allow us to maximize our capacity utilization and mitigate the shortage of skilled workers.”



SPRINT 3218: Up to 28 tool locations on 2 independent linear tool carriers enable highly productive production of workpieces with a diameter of up to 32 mm.



The MILLTAP 700 is used at Mechanik-Moduls for 5-axis machining of smaller workpieces. It is automated with a WH 3 Cell.



“The machines and automation solutions from DMG MORI are a central component of future-proof production. They allow us to maximize our capacity utilization and mitigate the shortage of skilled workers.”

**Daniel and brother Dominik Thoma**  
Managing Directors  
Mechanik-Moduls GmbH



Mechanik-Moduls manufactures complex and precise workpieces for demanding customers in the medical and aerospace industries, among others.

**MECHANIK-MODULS FACTS**

- + Established in Forstinning-Moos in 1990
- + 20 employees
- + Manufacturing service provider in the machining of precision components for the medical, semiconductor and aerospace industries



Mechanik-Moduls GmbH  
Römerstraße 10  
85661 Forstinning, Germany  
[www.mechanik-moduls.de](http://www.mechanik-moduls.de)



# PRECISION MACHINING FOR CUTTING- EDGE RESEARCH

The Max Planck Institute of Quantum Optics (MPQ) in Garching near Munich has its origins in a project group for laser research, which was founded in 1976 at the Max Planck Institute for Plasma Physics. It was awarded the status of a separate institute five years later. With four departments in different areas of laser development and quantum physics, the MPQ has been researching the interaction of light with quantum systems ever since. The departments of the institute deal with quantum matter at extremely low temperatures, the fundamentals of quantum optics and attosecond physics. It also focuses on experiments with individual quantum particles and information. The respective laboratories use complex, high-precision equipment, which is built with the support of the in-house workshop. 15 specialists manufacture precision components with the most demanding geometries on DMG MORI machine tools. The machine shop includes a DMU 40, a DMU 50 and a DMU 65 monoBLOCK for 5-axis simultaneous machining. There is also a CLX 450 for turning operations.

## Two Nobel Prizes in Physics

Research at the Max Planck Institute of Quantum Optics provides physicists with ever deeper insights into the microcosm. The results are so groundbreaking that two Nobel Prizes in Physics have already been awarded to Garching employees – the first in 2005 to Professor Theodor W. Hänsch for the development of laser-based precision spectroscopy. This technology can be used to determine the color of light from atoms and molecules with extreme precision. In this way, frequencies can be measured with an uncertainty of a few millionths

of a billionth of a hertz. Professor Theodor W. Hänsch researches high-precision laser spectroscopy of hydrogen and similar elements at the MPQ in the Emeritus Group for Laser Spectroscopy.

## EARLY DIAGNOSIS OF DISEASES THANKS TO ATTOSECOND PHYSICS

The Nobel Prize was awarded to Professor Ferenc Krausz in 2023. At the beginning of the century, he and his team succeeded in isolating a single X-ray pulse with a duration of 650 attoseconds. One attosecond corresponds to a billionth of a billionth of a second. This corresponds to the ratio of one second to the age of the universe. The interaction of electrons with each other or with light in matter also takes place on this unimaginably small time scale. It therefore requires extremely short exposure times to observe or control electrons at the atomic level in real time. This is exactly where attosecond physics can help. Professor Ferenc Krausz sees a practical benefit for medicine. After all, electron movements also play a role in biological systems. With this research, infrared, X-ray, and particle sources driven by femtosecond laser light are being developed and used for the early diagnosis and treatment of cancer.



» *Our laboratories need very special, high-precision optical instruments to carry out their experiments. The stability of the DMG MORI 5-axis machines and their extensive cooling systems allow the high-precision machining of the often complex geometries.*

» **Michael Rogg**  
Head of the workshop  
Max-Planck-Institut für Quantenoptik

### 5-axis simultaneous machining for complex, high-precision components

The high standards of research at the MPQ are also reflected in the in-house workshop. "Our laboratories need very special, high-precision optical instruments to carry out their experiments", explains Michael Rogg, who has been at the institute since 1986 and head of the workshop for 13 years. "Engineers design device components according to the specifications of the researchers, which we manufacture to the required quality and accuracy." For this task, the workshop team is equipped with modern 5-axis simultaneous machining centers from DMG MORI. The most recent acquisition was a DMU 40 in December 2023. "The stability of the machines and their extensive cooling systems allow precise machining of the often complex geometries," says Michael Rogg.

Complexity and precision on the one hand and the wide variety of materials on the other are what characterize the orders in the MPQ workshop. "As many experiments are carried out in a vacuum, stainless steel components are common, but aluminum, copper alloys or

special plastics are also used due to their individual properties," comments Michael Rogg on the wide range of materials. The challenge lies in taking the behavior of the diverse materials into account in the machining

## MAXIMUM MATERIAL DIVERSITY AND INDIVIDUAL MACHINING STRATEGIES

process. Another challenge is the individual machining strategies. The mostly small workpieces can be very delicate and this in turn requires machining that is as stress-free as possible. Michael Rogg mentions tolerances that are in the range of a few micrometers in extreme cases: "Even a thread cutter can cause unwanted deformations." That is why an M1 thread has already been milled on the DMU 65 monoBLOCK and not cut.



The Max Planck Institute develops and builds high-precision apparatus for its research in the fields of laser development and quantum physics. Such components are produced, in part, on high-precision 5-axis machines in its in-house workshop.



DMU 40

## THE ENTRY-LEVEL MACHINE FOR 5-AXIS SIMULTANEOUS MACHINING

- + Workpieces up to  $\varnothing 500 \times 445$  mm and 300 kg
- + speedMASTER spindles up to 20,000 rpm
- + Compact footprint < 5.1 m<sup>2</sup> and a machine width < 2 m
- + Integrated 5-axis simultaneous table with a  $-35^\circ / +110^\circ$  swivel
- + CELOS X with the new 24" control panel
- + Standard automation solutions PH 150 and Robo2Go Milling available



You can find a video on the DMU 40 here: [youtu.be/RCs74FKS0Fo](https://youtu.be/RCs74FKS0Fo)



The Max Planck Institute relies on the accuracy of 5-axis machines from DMG MORI for the production of its high-precision optical instruments. A DMU 50 and a DMU 65 monoBLOCK are used here in addition to a DMU 40.

### Motivated specialists with a willingness to learn

In production, one person is always responsible for the entire component – from programming through to final quality control. This is how Michael Rogg explains the high demand for good personnel: "Unlike in industry, profitability is only a secondary concern in research. What counts first and foremost is the perfect result. This means that we are looking for particularly motivated specialists and young people that are willing to learn." The MPQ is currently preparing three trainees for this exciting job.

### Longstanding partner in machining

In cooperation with research institutes, universities and vocational schools, the DMG MORI Academy is responsible for equipping the workshops. It is well aware of the requirements there and knows the differences to industry. In the case of MPQ, Michael Rogg can look back on many years of cooperation with the DMG MORI Academy: "We have been using CNC technology from DMG MORI for decades. With new purchases, we can be sure that we always receive manufacturing solutions that meet our stringent requirements."

### MAX PLANCK INSTITUTE OF QUANTUM OPTICS FACTS

- + Founded in 1976 from a project group for laser research at the Max Planck Institute for Plasma Physics
- + Status as an independent institute since 1981
- + 2005 the first Nobel Prize for the development of laser-based precision spectroscopy
- + 2023 the second Nobel Prize for the isolation of an X-ray pulse of 650 attoseconds



Max-Planck-Institut für Quantenoptik  
Hans-Kopfermann-Straße 1  
85748 Garching bei München  
Germany  
[www.mpq.mpg.de](http://www.mpq.mpg.de)



**WORLD  
PREMIERE  
2024**

# DMU 85 / 95 monoBLOCK 2<sup>nd</sup> GENERATION THE 5-AXIS CHAMPION!

**5 µm  
POSITIONING  
ACCURACY**

**HIGHLIGHTS**

- + 5 µm positioning accuracy and 30% higher volumetric accuracy thanks to directly driven ball screws
- + Exceptional accessibility to the working area – both stand-alone and automated!
- + High rigidity for heavy cutting with powerMASTER spindle SK 50 / HSK-A100 with up to 52 kW and 430 Nm
- + 5 in 1 Technology Integration: Milling, turning, grinding, gear cutting and measuring
- + Preparation for automation as standard, ideal for retrofitting
- + CELOS X with SIEMENS or HEIDENHAIN

Working area		DMU 85 monoBLOCK	DMU 95 monoBLOCK
Travels X/Y/Z	mm	935/850/650	950/850/650
Table size	mm	ø850 x 750	
Maximum table load	kg	1,000/1,500*	1,000

\*Swiveling rotary table with drive on both sides



Workpiece dimensions (mm)  
DMU 85/95 monoBLOCK

**AUTOMATION**

Increase your spindle hours through easy to use automation solutions



PH Cell 800: Pallet handling with unrestricted access to the working area from the front

**HIGHER ACCURACY!**

- + 5 µm positioning accuracy and 30% higher volumetric accuracy
- + Direct drive ball screws in the X/Y axes
- + Optimized drive in the rotary axes (A-/C-axis) for higher accuracy and less noise
- + Surface finish improvement through helical gear drive as well as short herringbone belt



**HIGHER THERMOSTABILITY!**

- + 20% higher temperature stability
- + Optimized thermosymmetric cooling of the machine ram for increased temperature stability
- + Powerful 5 kW cooling unit as standard, directly integrated into the machine



**HIGHER PRODUCTIVITY!**

- + Space-saving solution for up to 240 tools
- + HSK-A100/SK 50 optionally available
- + Setup during production



**INNOVATION  
2024**

# PH Cell 500

## INCREASE SPINDLE HOURS BY 300 % – PRODUCTION COSTS HALVED!

Versatile automation solutions are crucial for future-oriented production. The PH Cell 500 offers exactly this versatility and combines it with optimal ergonomics. It is based on the successful concept of the PH Cell 300 and consistently extends its advantages upwards in size. It is possible to store up to 32 pallets having a weight including the load of up to 500 kg each. Pallets of size 400 x 400 mm up to 500 x 500 mm can be used and combined.

### HIGHLIGHTS

- + Maximum transfer weight **500 kg** for workpieces up to **500 x 500 x 750 mm**
- + Up to **32 pallets**
- + **400 x 400 and 500 x 500 mm pallets**
- + **Modular concept** with optimal ergonomics and accessibility
- + **Pallet clamping cones** of steel
- + **Retrofit** possible with automation preparation

### RETRO-FITTABLE



**Available for:**  
– DMU 65/75 monoBLOCK 2<sup>nd</sup> Generation  
– DMU 65 H monoBLOCK



### MODULAR!

- + Pallet sizes and number of storage places freely selectable
- + 1 or 2 shelf modules configurable with up to 4 shelf floors
- + Selection of different clamping systems
- + Various set-up station designs available

### ERGONOMIC!

- + Excellent accessibility to the machine thanks to loading from the side
- + Separate ergonomic station for setting up the pallets during production
- + Crane loading directly into the working area from the front possible
- + Optimal service and maintenance access

### RETROFITTABLE!

- + Can be retrofitted to machines with automation preparation
- + The second shelf module can be installed at a later time
- + Pallets can be reordered

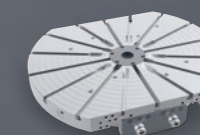

Also available for Mill-Turn machine pallets

### PH Cell Family For 300 to 2,000 kg transfer weight

PH Cell Series		PH Cell 300	PH Cell Twin	PH Cell 500 <span style="background-color: #f0f0f0;">NEW</span>	PH Cell 800	PH Cell 2000
Max. transfer weight	kg	300	300	500	800	2000
Max. workpiece dimensions	mm	500 x 500 x 750	500 x 500 x 500	500 x 500 x 750	ø800 x 800	ø1,100 x 1,350
Max. number of pallets		40	30	32	30	21
Minimum pallet size	mm	320 x 320	320 x 320	400 x 400	400 x 400	630 x 630
Maximum pallet size	mm	500 x 500	500 x 500	500 x 500	ø800 x 630	ø1,100





Since 1983, Sankt Augustin-based company Peter Josef Klein Feinmechanik GmbH (PJK) has been producing precision components for customers in the medical and food sectors and also in the aerospace sector as a long-standing partner of the German Aerospace Center. The company portfolio includes complex components and assemblies made from aluminum, titanium, stainless steel and high-performance plastics. The PJK team consists of 50 experienced specialists who are experienced in all of the metalworking disciplines. For metalcutting, they mainly use automated machine tools from DMG MORI, including seven DMU 60 eVo machines, all of which operate automatically. Two of them are connected via a pallet handling system, which has 40 pallet locations and can accommodate 300 fixtures. An MTS zero point clamping system is used as the basis for the flexible automation solution.

**Integrated customer support from planning to series production**  
Due to the fact that it works with orders from demanding industries on a daily basis, PJK has a very customer-oriented philosophy. Peter Klein, who runs the company with his brother in the second generation, summarizes the situation as follows: "We accompany our customers from consultation to

finished product, from prototype to series production." The challenge lies in the extreme quality requirements and the high degree of competitive pressure. Julian Klein adds: "Our components are accurate to within microns, but we also have to continuously check and optimize our processes at the same time."

## MAXIMUM UTILIZATION BY MEANS OF CONSISTENT AUTOMATION AND 5-AXIS MACHINING

One method of achieving this optimization is autonomous manufacturing. PJK has been using automation solutions to maximize the utilization of its machines since 2011. "On one hand, our employees can operate several machines during the day shift in this way, and on the other, we also use unmanned night and weekend shifts," explains Peter Klein. This increases both the capacity and the flexibility of our production. »

# AUTONOMOUS 5-AXIS PRECISION MACHINING AROUND THE CLOCK



Two of the seven DMU 60 eVo machines are connected via a pallet handling system. This has 40 pallet locations and also has room for 300 fixtures which can be swapped onto the pallets.



PJK Feinmechanik manufactures complex precision components made from aluminum, stainless steel and high-performance plastic.



*The fact that the newly integrated zero point pallets are mounted directly in the work table maximizes the amount of work space and minimises the risk of collisions.*

Peter and Julian Klein (right)  
Managing Directors of  
Peter Josef Klein Feinmechanik GmbH

#### DMU eVo: Dynamics and precision in 5-axis machining

PJK has been using DMU 60 eVo universal machining centers for many years. In order to achieve even more precise and dynamic machining, the majority of the machines are equipped with linear drives. "The machines produce our range of components by 5-axis machining in an optimum way and fulfill our tight tolerances at the same time," says Julian Klein, evaluating the manufacturing results. "We mainly operate in the micrometer range and have to consistently guarantee these accuracies." Automated production also makes a contribution to quality: "In this way, we reduce the number of manual reclampings, which can also lead to inaccuracies."

#### MTS clamping system: Space-saving and stable interface for pallet changing

For the two DMU 60 eVo machines integrated into the large pallet handling system, DMG MORI has developed a table that has an embedded MTS zero point clamping system. Julian Klein explains the move: "The original table took up too much room with a fixture mounted. The new solution is flatter and has a smaller circumference." This maximizes the work area and minimises the risk of collisions. "The machining also becomes more stable, which improves the precision." Peter Klein sees a major

advantage in the flexibility of the pallet handling: "The clamping system makes it possible to use conventional pallets equipped with towers for series production or with traditional vices." This leads to a very wide range of components the two DMU 60 eVo systems can machine completely autonomously.

#### Reliable production thanks to DMG MORI Full Service\* and myDMG MORI

Being equipped with these kinds of flexible and autonomous manufacturing solutions means that PJK needs high machine reliability. In the case of large pallet handling, the seven DMU 60 eVo machines are in continuous use for up to 22 spindle hours per day. "Long downtimes would have a detrimental impact on operations," says Peter Klein. "This is why service plays such a crucial role in our collaboration with DMG MORI." When it purchased the DMU eVo models, PJK decided on DMG MORI Full Service\*. The all-round, care-free package includes all service, travel and spare parts costs as well as annual maintenance for customers in Germany, Austria and Switzerland. It includes Allianz machine breakage insurance. "We also make intensive use of the myDMG MORI online portal, because service processes are handled transparently and quickly in this way," adds Julian Klein.



DMU 60 eVo

## HIGH-PRECISION 5-AXIS MACHINING

- + Workpieces up to  $\varnothing 750 \times 525$  mm and 400 kg
- + speedMASTER spindles up to 20,000 rpm or 200 Nm
- + High-speed spindles up to 40,000 rpm
- + Maximum accuracy thanks to integrated cooling and linear drives (optional)
- + 4 in 1 process integration: 5-axis milling and turning (FD), gear milling, ULTRASONIC and in-process measurement
- + Versatile automation solutions – can also be retrofitted



A video of the DMU eVo model series can be found at: [youtu.be/pryjZ4Qv8rw](https://youtu.be/pryjZ4Qv8rw)

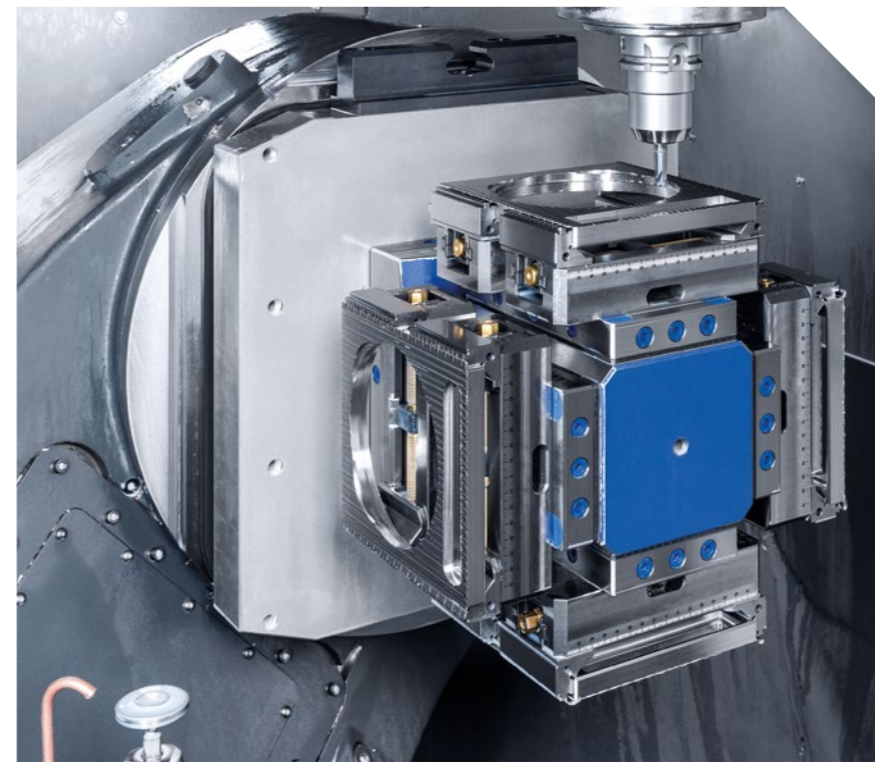

For optimal use of the working space, the two DMU 60 eVo machines have an MTS zero point clamping system embedded directly in the table.

#### Digitally into the future

Digital solutions such as myDMG MORI are a blessing for PJK, as Peter Klein explains: "We utilize all of the possibilities of digitization in both service and production. It starts with the CAD/CAM system and ends with computer-aided quality control CAQ." The CRM makes highly flexible order planning in automated production possible, adds Julian Klein: "For example, if a tool breaks and the machine stops, the system introduces a new tool so that production doesn't grind to a halt." The consistent focus on automation and digitization is a decisive competitive factor. "Our further investments will therefore also be channeled specifically into future-proof production."

\*DMG MORI Full Service is currently available in Germany, Austria and Switzerland as well as the Czech Republic and Hungary. For comparable offers, please speak to your personal DMG MORI contact.

#### PETER JOSEF KLEIN FEINMECHANIK FACTS

- + Established in 1983 in St. Augustin
- + 50 employees
- + Manufacture of complex precision parts made from aluminum, stainless steel and engineering plastics
- + Customers in the medical sector, the food industry and mechanical engineering in general



Peter Josef Klein Feinmechanik GmbH  
Westerwaldstraße 18  
53757 Sankt Augustin, Germany  
[www.feinmechanik-pjk.de](http://www.feinmechanik-pjk.de)



**WORLD  
PREMIERE  
2024**

# DMF 400|11

## EXPANSION OF THE DMF SERIES INTO A NEW DIMENSION

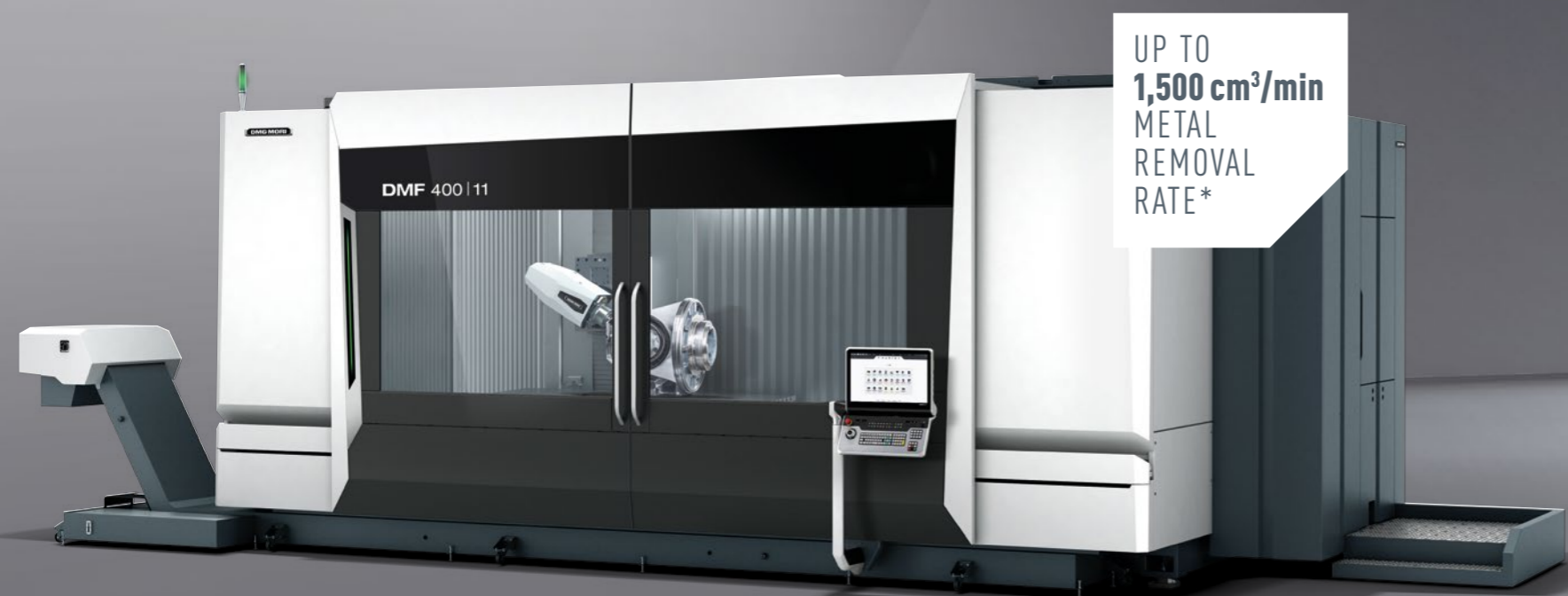

UP TO  
**1,500 cm³/min**  
METAL  
REMOVAL  
RATE\*

### HIGHLIGHTS

- + Large work area with 4.7 m² and travels of X = 4,000 mm / Y = 1,100 mm / Z = 1,050 mm for workpieces up to 8,000 kg
- + Maximum rigidity thanks to 3 linear guideways in the X-axis and consistent overhang of the traveling column
- + speedMASTER spindles up to 20,000 rpm or 200 Nm, powerMASTER spindles with 12,000 rpm and up to 430 Nm (SK 50)
- + Extensive table options with fixed table, one or two integrated rotary tables, as well as a mill-turn table or simultaneous A-axes
- + Mill-Turn technology integration as well as innovative DMG MORI technology cycles, such as interpolation turning 2.0, angularTOOL or gearSKIVING available

### WORKPIECE DIMENSION 3 AXES (tool length: 100 mm)

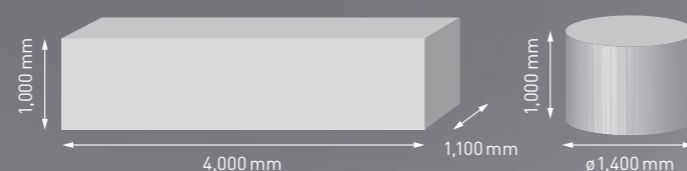

### MAXIMUM FLEXIBILITY COMBINED WITH MAXIMUM PRODUCTIVITY THROUGH SETUP DURING MACHINING

Pendulum machining with easy-to-integrate separating wall creates an alternative to a machine with pallet changer, combined with flexibility for processing long components. Optional connection of automation solutions via factory interfaces.

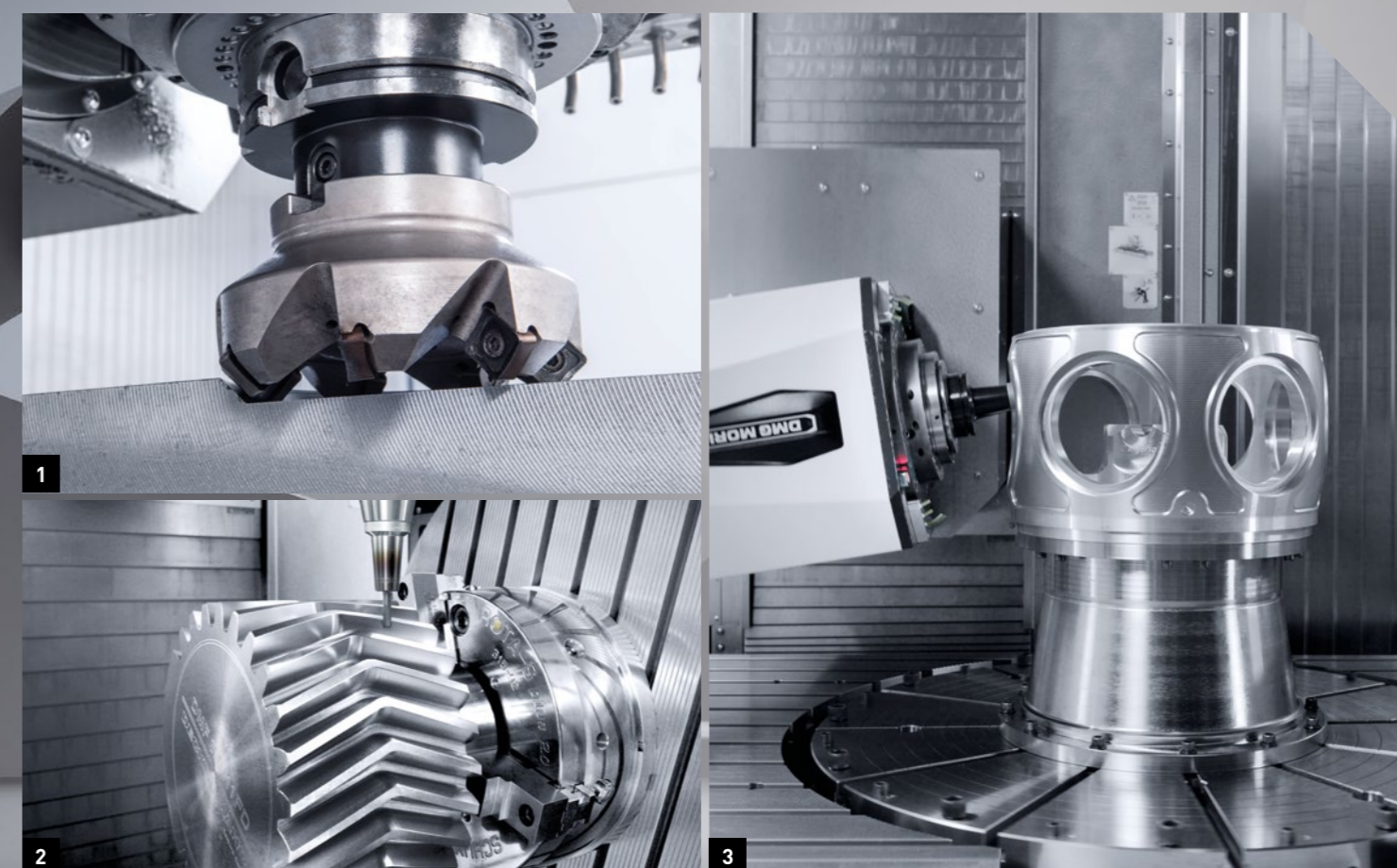

1. Machining CK45 with cutter head 100 mm (F: 1,500 mm/min; APP: 9 mm) 2. Machining of a gear wheel with DMG MORI technology cycle gearMilling 3. Mill-turn machining at up to 700 rpm and a maximum workpiece weight of 1,200 kg

### DMG MORI SEEBACH: THE EXPERTS IN THE FIELD OF TRAVELING COLUMN MACHINES

- + **Expansion of the DMF series:**  
Integration of the new DMF 400|11 completes the new traveling column series
- + **Concentration of traveling column competence at DMG MORI in Seebach:**  
A universal concept with a flexible modular build system
  - The right solution for every requirement
  - DMV: 3-axis vertical machining (X-axis: 1,150 to 1,850 mm)
  - DMF: 5-axis simultaneous machining\* (X-axis: 2,000 to 4,000 mm)

\*5<sup>th</sup> axis optional

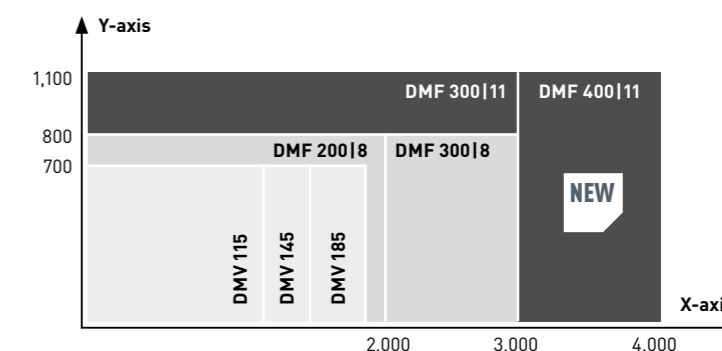

DMV	DMF	
<b>DMV 115</b> X/Y/Z: 1,150/700/550 mm		
<b>DMV 145</b> X/Y/Z: 1,450/700/550 mm	<b>DMF 200 8</b> X/Y/Z: 2,000/800/850 mm	<b>DMF 300 11</b> X/Y/Z: 3,000/1,100/1,050 mm
<b>DMV 185</b> X/Y/Z: 1,850/700/550 mm	<b>DMF 300 8</b> X/Y/Z: 3,000/800/850 mm	<b>DMF 400 11</b> X/Y/Z: 4,000/1,100/1,050 mm
4-axis machining with indexing head	5-axis simultaneous machining	
Y-axis travel: 700 mm	Y-axis travel: from 800 mm to 1,100 mm	



The new INH 63 has not only boosted productivity but also sparked new motivation on the shop floor and improved the working atmosphere.

# IN PURSUIT OF HARMONY: 100-YEAR-OLD MANUFACTURER EMBRACES INNOVATION WITH INH 63

KUSUDA Co., Ltd. was established more than 100 years ago in 1920. The company started as a castings provider, but entered the machining field in the 1980s for higher business value. Since then, Kusuda has achieved significant growth by developing a unique system to handle the whole process by themselves, from casting to machining and on to product delivery.

## INH 63 AND CPP DRIVE PROCESS INTEGRATION AND AUTOMATION FOR HIGHER PRODUCTIVITY

Kusuda continues to uphold its philosophy of "Harmony and Progress" to this day with its state-of-the-art technology, machine tool parts and castings that directly contribute to the development of manufacturing industry. Kusuda has been a supplier of DMG MORI since the very beginning, providing various parts such as spindle housings and flanges. On the other hand, Kusuda has also been a user of DMG MORI machines since the 1980s, with approximately 40 machines currently in

operation. In constant pursuit of innovation, Kusuda has used the 5-axis machining center DMU 50 and the NLX 2500 with touch screen control panel and CELOS since the 2010s. Since 2023, it has been a pioneering user of the new 5-axis machining center INH 63.

### Process integration for fewer setups Significantly higher productivity and operator safety

Kusuda handles all processes from casting to machining in its own high-mix, low-volume production system, which produces components up to 200 kg. Conventionally, these processes require time-consuming setups on 3-axis and 4-axis horizontal machining centers. But with the INH 63,

processes can be integrated and the number of setups drastically reduced. Mr. Kiyoto Kusuda, manager of the sales department, adds: "With large or heavy pieces, setups can be dangerous. Consequently, process integration leads to less hazardous work and enhanced safety for our staff." The INH 63 utilizes a powerful spindle with a standard maximum spindle torque of 808Nm and a spindle output of 85/40 kW (10% DC/cont.). This enables both heavy-duty and high-speed machining, thus boosting productivity.

### INH 63

## EQUIPPED WITH DMG MORI'S CUTTING-EDGE TECHNOLOGY FOR ZERO DOWNTIME

- + Process integration for **fewer setups**
- + Significantly higher productivity and **operator safety**
- + **zero-sludgeCOOLANT pro** to greatly reduce tank cleaning
- + Twin ball screws in all axes and slanted column for **high precision and rigidity**
- + **powerMASTER spindle** for heavy-duty and high-speed machining
- + Promotes energy-saving and **sustainability** with process integration and automation



A video about INH 63 is available on our website: [youtu.be/Pwcez\\_OfEoo](https://youtu.be/Pwcez_OfEoo)



Casting process by metal melting and pouring at temperatures exceeding 1,000°C.



Machining setup on the operation panel ERGOline X with CELOS X.



High-mix low-volume production of various parts.



“The INH 63 greatly benefited our machining capabilities. We will further promote our unique integrated production systems, covering all processes from casting to machining.”

**Kiyoto Kusuda**  
Manager, Sales Department  
KUSUDA Co., Ltd.

**CPP pallet handling system for high-mix production with maximized machine utilization**

Kusuda manufactures its in-house castings to be near net shape, which enables higher efficiency during machining and shorter lead times compared to machining from billets. To increase the machine utilization further, unmanned night shifts with a large number of pallets are necessary. For Kusuda, this meant purchasing the INH 63 with an 8-station CPP [Compact Pallet Pool].

“Actually, our factory floor space would have limited us to only 6 stations in the standard design, but thanks to DMG MORI’s special design, we were able to install the larger 8-station CPP,” Mr. Kusuda recalls. In addition, the technology cycle CELOS Chatter Control is employed to automatically optimize cutting conditions. “By avoiding chatter on the finished surface, we can reduce our workload and improve productivity. Moreover, the tool management system allows us to machine safely without overworking the tools, and even if a tool is damaged during night shift,

the tool breakage detection prevents accidents”, says Mr. Kusuda, appreciating the productivity-enhancing features.

**Protection against chips, coolant and mist to improve the working environment**

The INH 63 utilises the new zero-sludge COOLANT pro, an evolved version of the original zero sludge coolant tank with high-performance chip evacuation capabilities to prevent chips accumulating inside the machine and support long periods of unmanned operation. Why is it crucial to reduce tank cleaning? Mr. Kusuda recalls past workloads and states that: “Sludge accumulates quickly in the coolant tank because we mainly machine ferritic cast iron. In the past, three staff spent a whole day cleaning the tank two to three times a year.”

The built-in mist collector zeroFOG collects more than 99.97% of particles as fine as 0.3µm in diameter, preventing problems caused by mist. Mr. Yamanaka smiles: “Thanks to zeroFOG, the machine is not filled with mist at all and the view is really clear.

I can machine without worrying about cutting conditions, which improves production efficiency.” To which Mr. Kusuda adds: “And a cleaner working environment means better operator health.”

**Seeking growth and sustainable production with the latest technology**

When President Yoshinori Kusuda first heard of the INH 63, the new machine immediately caught his attention. Originally, he had planned to replace the company’s existing 4-axis MH-63 with an NHX 6300 2nd Generation, another horizontal machining center capable of 4-axis machining, but suddenly changed his direction. What caused him to rethink the investment?

“The INH 63 perfectly embodies our corporate identity: to grow together with our customers through the latest technology, equipment and services. We believe that the INH 63 and its concept of process integration for high-speed, high-precision machining will be a powerful asset to further promote our unique strength, that is the full in-house casting production from raw material to machined products.

In addition, the INH’s energy-saving performance proved ideal in terms of both sustainable production and contribution to the realization of a carbon-neutral society.” Another crucial factor was the attention to detail that went into the design of the INH 63.

“The machine uses two torque motors to drive the swivelling rotary table in the A-axis for high rigidity, which shows how much the machine has evolved in terms of its basic structure and chip disposal performance. Also, the INH is stylish to look at and greatly motivates our operators”, Mr. Kusuda concludes.

**KUSUDA CO., LTD. FACTS**

- + Established in 1920
- + Contributes to society as a specialized manufacturer of cast iron and castings
- + Integrated production from casting to machining on the same site
- + Actively adopts the latest technology and equipment to improve productivity and the working environment
- + Home of many skilled technicians certified in machining

株式会社 **777**

KUSUDA Co., Ltd.  
Headquarters/Factory:  
2140 Oudashimocha,  
Uda-city, Nara 633-2170, Japan  
<http://kusuda.co.jp/index.html>



CTX beta 1250 TC 4A

## COMPETITIVE THANKS TO AUTOMATION AND COMPLETE MACHINING

TITAN is the product brand of the Lenzen Group, which was founded in 1842. The fifth-generation family business is led by sole shareholder Peter Wilhelm Lenzen and employs 350 people at three German production sites and other sales companies abroad. It is one of the leading manufacturers in the strapping industry. Its range of services includes the production and sale of high-quality strapping solutions for customers in all sectors, including the steel/metal, building materials and wood industries. As a solution provider, the Lenzen Group produces the complete range of strapping materials and machines, from strapping bands, hand tools and accumulators to special machines. The design, manufacture and final acceptance of the customized machines is carried out by TITAN Umreifungstechnik GmbH & Co. KG in Schwelm. To ensure the competitiveness of the site, the company relies on modern production concepts and fully automated unmanned shifts. One investment, in 2024, was in three automated production solutions from DMG MORI. Two NHX 5000 3<sup>rd</sup> Generation machining centers work fully automatically, connected via an LPP with

40 pallet spaces, as do two robotically-automated DMU 60 eVo machining centers and a CTX beta 1250 TC 4A turning center with the latest version of Robo2Go.

### Strapping for all standard materials

Building materials, hay bales, rolls of steel or parcels in logistics – TITAN's intelligent solutions are as diverse as the goods that need to be strapped. "Our development department designs integrated special machines that meet the respective requirements optimally with regard to the size, speed and stability of the strapping," explains Dirk Peters, Plant Manager at TITAN. The expertise required for this is the company's greatest strength. "The fact that we offer these solutions for strapping with all standard materials and all technology variants is our unique selling point." What all solutions have in common is reliable strapping. Whether welded or pressed – the strapping must be able to withstand the highest tensile loads.

In addition to innovation-oriented development, the strict quality standards require high part quality in component production. The key units of the special machines are manufactured entirely on the factory floor. The batch sizes are naturally small, while the requirements for precision and complexity of the workpieces are high.



“A high degree of process integration and flexible automation solutions are an integral part of future-oriented production.”

Dirk Peters  
Plant Manager  
TITAN Umreifungstechnik GmbH & Co. KG



TITAN's range of services includes the production and sale of high-quality strapping solutions for customers in all sectors.

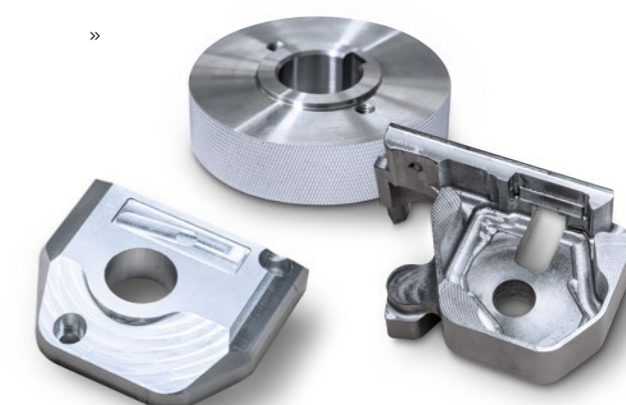



NHX 5000 WITH LPP

## PALLET POOL AS A TURNKEY SOLUTION

**NHX 5000 3<sup>rd</sup> Generation:**

- + Workpieces up to  $\varnothing 800 \times 1,000$  mm and max. 500 kg
- + 100 rpm direct drive table
- + Maximum rigidity thanks to massive machine bed and 3-point support
- + CELOS with MAPPS or SIEMENS

**LPP:**

- + Extremely flexible pallet pool system with up to 8 machines, 99 pallets and 5 setup stations (10 machines and 199 pallets possible on request)
- + Handling of up to three different pallet sizes possible in one system (2 sizes for machine pallets and one size for material pallets)

**NHX 5000 3<sup>rd</sup> Generation: highly productive horizontal machining with LPP**

"We have been using machine tools from DMG MORI for many years now, because they machine such workpieces perfectly," says Dirk Peters describing his machine capacity. "Nevertheless, we had to find a way to make production significantly more cost-efficient in order to remain competitive." TITAN has embarked on this path with major investments in automated machining. The greatest increase in capacity was achieved by two NHX 5000 3<sup>rd</sup> Generation machines. Connected via a linear pallet storage system with 40 pallet stations, the horizontal machining centers work without any significant idle times. Volker Hille, Production Manager, points to the two setup stations: "We load the towers with a wide variety of components while other pallets are being processed." The orders can be managed transparently via the Cell Controller LPS 4. The NHX 5000s at TITAN are equipped with CELOS on SIEMENS.

**CTX beta 1250 TC 4A: 6-sided turn-mill machining with Robo2Go and gearHOBBING**

The latest highlight in automated production is a CTX beta 1250 TC 4A with Robo2Go. Equipped with the compactMASTER turn-mill spindle and a second tool carrier, the machine can cope with any challenge in 6-sided complete machining. The integration of several manufacturing processes extends to gear hobbing, as Volker Hille explains: "The gearHOBBING technology cycle allows us to use a hobbing cutter to produce the finest gear teeth on the components, which are responsible for transporting the straps." This machining process was anything but trivial, recalls Dirk Peters: "The fact that DMG MORI found a machining strategy for this was a decisive factor for the investment." DMG MORI installed a bar feeder and the latest version of Robo2Go Turning as an automation solution. The robot has a magazine cabinet with up to five drawers in which the raw parts and finished workpieces can be stored. One function of the new Robo2Go was developed by DMG MORI in collaboration with TITAN, says Volker Hille: "We wanted to integrate automatic remnant removal so that the machine can also change over to the next bar unmanned."

**DMU 60 eVo: flexible automation of 5-axis machining**

Two DMU 60 eVo machines complete the range of new production solutions. Here too, the focus is on machining the components as completely and automatically as possible. Complex geometries that require economical 5-axis simultaneous machining are characteristic of many of TITAN's special designs. Autonomous operation is made possible by robot automation. Like the Robo2Go, it has a magazine cabinet for workpiece storage. There are an additional 38 pallet stations available on the other side of the cell. "This gives us maximum flexibility in the 5-axis machining of complex single parts and small batch sizes," says Dirk Peters, assessing the added value for production.

**Automation and process integration as standard**

The substantial investment in the area of automated parts machining will quickly pay off for TITAN, as Dirk Peters confirms: "We can already see from the spindle hours, for example, that our capacity utilization has increased significantly." That is why he intends to consider other manufacturing solutions from DMG MORI for future projects in order to ensure long-term success in the market for TITAN products. "The

experience we gained with the first purchases has shown us that a high degree of process integration and flexible automation solutions are the standard for future-oriented production." Securing the future viability and technological leadership of the company is the driving force for Peter Wilhelm Lenzen to continue to expand: "Modern manufacturing concepts based on automated production centers strengthen our position in Schwelm." Valuable skilled workers are available during the day, while during late and night shifts, unmanned production comes into play. "The aim is to configure a factory that meets the challenges of the future in terms of employee satisfaction and the skills shortage."

- 1.+2. Great increase in capacity by two NHX 5000 3<sup>rd</sup> Generation machines. Connected via a linear pallet storage system with 40 pallet stations, the horizontal machining centers work without any significant idle times
- 3. Automated production on CTX beta 1250 TC 4A with Robo2Go.
- 4. Maximum flexibility in 5-axis machining of complex parts. Autonomous operation of two DMU 60 eVos with robot automation and a cabinet with space for 38 machine pallets.

**TITAN UMREIFUNGS-TECHNIK FACTS**

- + TITAN is the product brand of the Lenzen Group, founded in 1842
- + 350 employees in the fifth-generation family business
- + High-quality strapping solutions for customers in all sectors, e.g. steel/metal, building materials and wood industries



Titan Umreifungstechnik GmbH & Co. KG  
Berliner Str. 51, 58332 Schwelm  
Deutschland  
[www.titan-schwelm.de](http://www.titan-schwelm.de)



**WORLD  
PREMIERE  
2024**

# NHX 10000 $\mu$ Precision

## HORIZONTAL 4-AXIS MILLING WITH 15 $\mu$ m VOLUMETRIC ACCURACY

**15  $\mu$ m**  
VOLUMETRIC  
ACCURACY

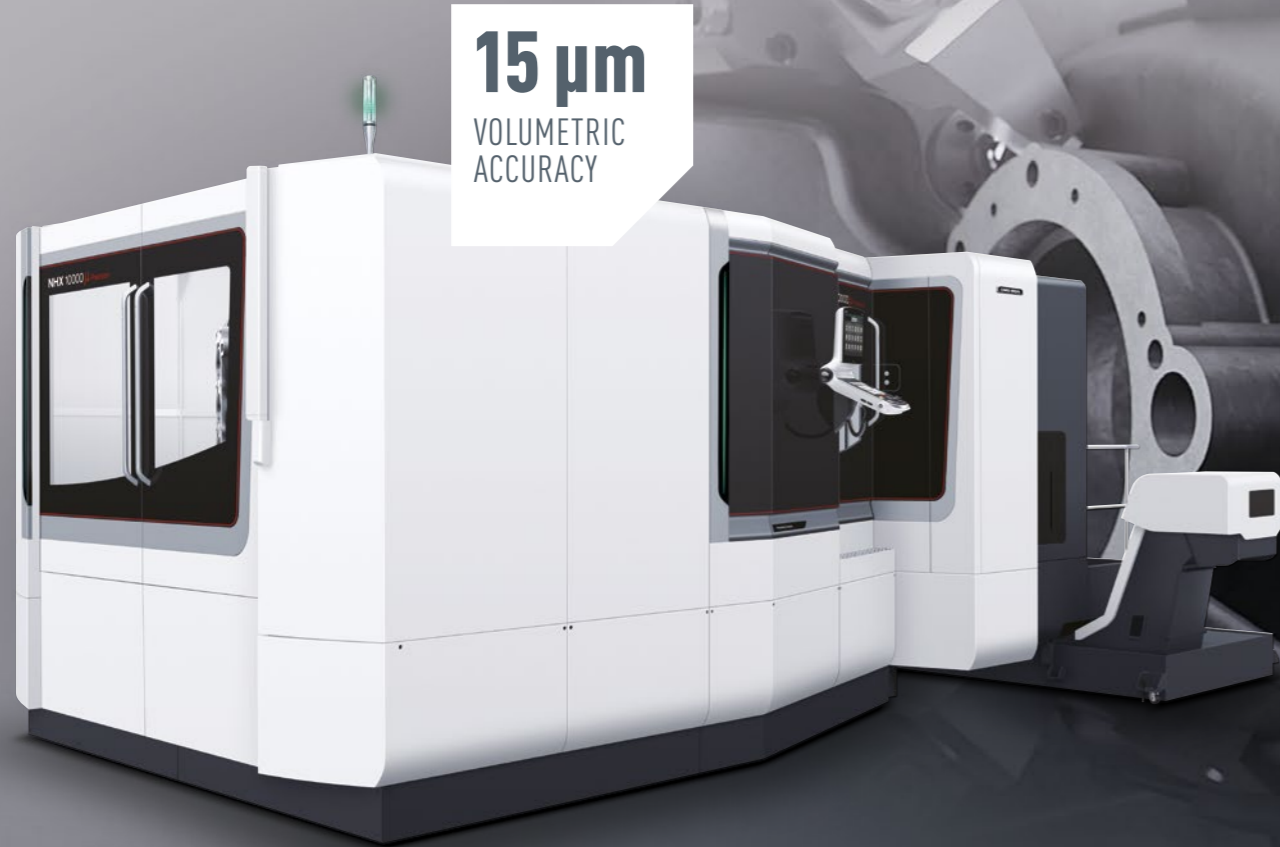

“  
This product combines heavy-duty machining of large workpieces with outstanding precision.  
”

### CELOS X

#### INTUITIVE, SIMPLE, EFFECTIVE

- + Simplified operation **reduces human error**
- + Full overview of your machines **everywhere**
- + Your optimization for **DX & GX**
- + **CELOS X on MAPPS** (from 07/2025)

Working area		NHX 10000 $\mu$ Precision
Max. workpiece size	mm	ø2,000×1,400
Table size	mm	1,000×1,000
Max. table load	kg	3,000 (5,000*)
powerMASTER (#50/HSK-A 100)		
Standard	rpm   Nm	12,000   807
High Speed	rpm   Nm	16,000   528*
High Torque	rpm   Nm	8,000   1,413*

\*optional

## YOUR NHX WITH **MX**

#### PROCESS INTEGRATION



- + In-process measuring
- + Gear cutting

#### AUTOMATION



- + LPP | multi level racks – up to 99 pallets
- + CPP | compact pallet pool – up to 6 pallets

#### GX – GREEN TRANSFORMATION

- + **GREENMODE** Package
- + Advanced Auto Shutdown
- + Energy efficiency

#### DX – DIGITAL TRANSFORMATION

- + Interpolation turning
- + MPC – Machine Protection Control
- + MVC – Machine Vibration Control

### $\mu$ Precision HIGHLIGHTS OF THE NHX 10000

- + Separate cooling system for Y-Axis to minimize thermal displacement
- + *zero-sludge*COOLANT Tank as standard
- + Multiple temperature sensors and compensation (e.g. oil chiller)
- + SmartSCALE as standard in all axes for highest accuracy
- + Rapid acceleration up to 0.62 g thanks to the Center of Gravity build
- + High precision full 4<sup>th</sup> axis rotary table (DDM; max. 20 rpm)

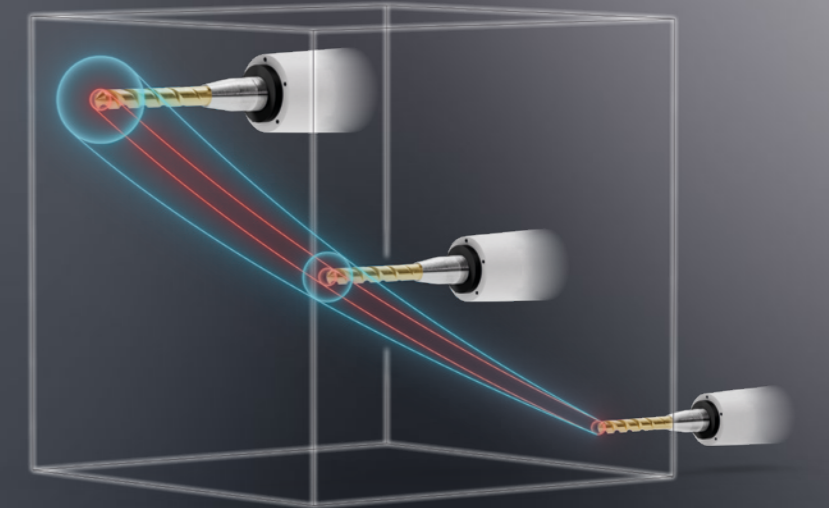

Parameter	NHX 10000 $\mu$ Precision
Volumetric accuracy	15 $\mu$ m or less
Positioning accuracy (X/Y/Z)	6/6/6 $\mu$ m (full stroke)
Pallet indexing table	0.001°

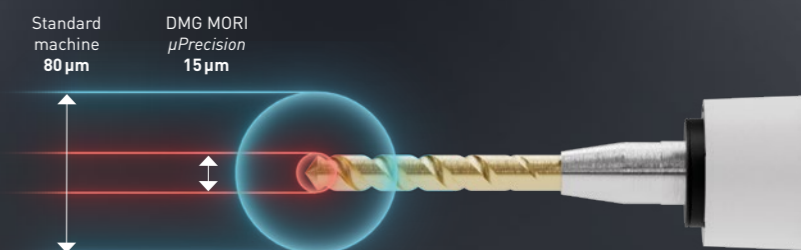



**INNOVATION  
2024**



# PH-AMR 750

## PALLET HANDLING WITH DRIVERLESS VISION!

The PH-AMR series is an important innovation for the digital factory of the future. It enables fully automated loading and unloading of machine or zero point pallets into machine tools. It is the beginning of a new era of flexible automation solutions in intralogistics. Depending on the workpiece or pallet size requirements, various PH-AMR sizes are available for autonomous and collaborative pallet transport.

### HIGHLIGHTS

- + Collaborative automation solution with free layout design
- + Omnidirectional movement for minimum space requirements (turning circle 0m)
- + Free access to machine without safety fences
- + Simple extension with additional machines
- + Maximum transfer weight up to 750 kg
- + Transport of machine pallets from 500 x 500 mm to ø 800 x 630 mm

### PH-AMR series



Machine type		PH-AMR 750	PH-AMR 1500	PH-AMR 3000	PH-AMR 5000
Pallet sizes	mm	500x500 ø 630 630x630 ø 800x630		1,000x800 ø 1,100 800x800 ø 900x800	1,250x1,000 ø 1,400 1,600x1,250
Max. workpiece dimensions*	mm	800x800x800	950x950x1,350	1,250x1,250x1,350	1,600x1,600x1,350
Max. transfer weight	kg	750	1,500	3,000	5,000
AMR dimensions	mm	1,480x990x1,810	2,600x2,000x2,930	3,110x2,160x3,200	3,710x2,660x3,200

\*Depending on the machine tool



### LPS 4

## THE MASTER CONTROLLER FOR ALL AUTOMATION SOLUTIONS

- + Pallet, workpiece & tool handling
- + Tool administration and tool management
- + Fixture management
- + AMR & AGV control
- + CELOS Job Manager
- + Reporting & evaluation functions such as OEE

>> Modular software modules that can be precisely adapted to any customer requirement

# AMR 2000

AMRs move collaboratively with people in the same system and can avoid obstacles. The AMRs 2000 platform can transport workpieces, Euro pallets, tools and chip containers from external storage to the machines.



MATERIAL HANDLING

CHIP DISPOSAL

### TOOL HANDLING

Tool dimensions	ø 280 / 400 mm
Maximum tool weight	30 kg
Transport weight	720 kg (24x30 kg)
Maximum number of tools	24 pcs

### Technical data

Total weight loaded (incl. battery)	2.75 t
Maximum loading weight	2 t
Maximum speed	6 km/h
Material Handling Pallet Size	1,200 x 800 mm
Turning circle	0 m
Battery technology	Lithium Ion
Safety engineering	Sick + SIEMENS
Cell Controller	LPS 4

### HIGHLIGHTS

- + Basis for additional tasks, e.g. material handling, chip handling and tool handling
- + Extends the autonomy of the machine overnight or over the weekend
- + Integration into existing processes
- + Maximum transport weight of up to 2,000 kg

# PROCESS OPTIMIZATION THANKS TO LASER SHARPENING OF TOOLS



“We can machine our tools efficiently thanks to the LASERTEC 50 PrecisionTool. The service life increases significantly, which gives us an important competitive edge!”

**Gabriele Borri**  
Founder and Managing Director  
of MICROTECH

Gabriele Borri and Orlando Carciofi founded MICROTECH in Appignano in 1980 to manufacture high-quality diamond tools for woodworking. Today, the 30-strong team produces a wide range of products for customers in 45 countries all over the world and is one of Italy's top companies for the manufacture of PCD tools for woodworking. Previously, the hard diamond cutting edges were always sharpened on eroding and grinding machines. However, since 2022, MICROTECH has been using a new technology: The company has invested in a LASERTEC 50 PrecisionTool in order to machine the tools in a more efficient, precise and sustainable way. MICROTECH productivity has increased even further with robot automation, which has been developed in-house. It makes unattended shifts possible through a high degree of autonomy.

**Custom diamond tools for woodworking**  
“Be it saw blades, milling cutters or drills – we develop and produce our PCD tools individually in accordance with our customers' requirements,” explains Gabriele Borri. The precision tools are often used in furniture manufacture, where they have a long service life thanks to their hard cutting edges. Wood, plastic and even lightweight metal alloys can be machined with high precision. “Of course, we also sharpen worn tools so that they remain in use for as long as possible.”

LASERTEC 50  
PrecisionTool:  
WIDE RANGE OF  
COMPONENTS  
UP TO ø 355 mm

The goal of MICROTECH is to continually optimize manufacturing processes and supply top quality tools. “A large proportion of our machinery is automated and we are always looking for new machining technologies,” says Gabriele Borri. An addition to eroding and grinding has been discovered in the form of laser machining. “With the LASERTEC 50 PrecisionTool, DMG MORI has a machine in its armory that fulfills all of our requirements – with numerous advantages over conventional technologies.” The compact machine only requires a footprint of 4 m² and covers a wide range of components, allowing MICROTECH to machine small milling cutters and also large tools up to ø355 mm in diameter with different clearance angles. The definitive influence on cutting edge preparation, which can be easily implemented by the laser, has significant potential particularly for the performance of the tools during machining.



LASERTEC 50 PrecisionTool

## QUALITY AND TIME ADVANTAGES FOR DIAMOND TOOLS UP TO $\varnothing$ 355 mm

- + Linear drives with acceleration of  $>1g$  and highly dynamic torque motors in both rotary axes (B-axis and C-axis)
- + Travels in X/Y/Z: 540 mm  $\times$  500 mm  $\times$  700 mm
- + CCD camera and 3D touch probe for quick setup
- + PCD, CVD and CBN diamond tools up to  $\varnothing$  355 mm / length 420 mm / 30 kg
- + Up to 210% higher speed and up to 56% lower machining cost compared with spark erosion
- + Option: PH 50 – pallet automation for maximum productivity



A video of the LASERTEC 50 PrecisionTool can be found at: [youtu.be/1dzmr1NjcJ4](https://youtu.be/1dzmr1NjcJ4)

### 5-axis machining of complex tools in a single clamping

Thanks to it being easy to use and clean, since no coolants are required, the LASERTEC 50 PrecisionTool has won the hearts of the employees within a very short time. DMG MORI has implemented the GTR industry standard as the programming solution at job shop level, meaning that existing eroding projects can also be included.

Sauro Bravi, who is responsible for laser machining, was quickly able to program even the most complex processes following his training in Pfronten. "The 5-axis machine can also machine in a single clamping adjustable jointing cutters consisting of several blades. This has to be done in several steps on grinding machines. The laser allows me to manufacture tools repeatably, since factors such as PCD grain size, grinding wheel shape, dielectric material and accessibility of the wheel do not have any direct influence during laser cutting."

Repeatable laser machining of cutting edges – independent of grain size, dielectric material or grinding wheel geometry.



From left to right: Laura Borri, Luca Carciofi and Elena Borri will lead MICROTECH into the second generation of ownership.



Maximum utilization in unattended multi-shift operation by means of automated component handling.

### High productivity thanks to automated production

The fast speed is also impressive, adds Gabriele Borri. Linear drives in the X and Y axes accelerate at up to 1g and the two rotary axes have highly dynamic torque motors that are ideal for repeatability and long-term stability. "Overall, we were able to significantly increase our productivity – particularly thanks to the robot automation we connected." Overnight and at weekends, the storage always contains workpieces that need to be machined, so the LASERTEC 50 PrecisionTool is utilized to the maximum during unattended shifts.

processing increases the service life by a factor of as much as 2.5 in some cases. The longevity of the laser source and the low maintenance costs of the LASERTEC machine are further competitive advantages that help to keep down the cost of manufacturing. The outstanding repeatability of the lasered results in particular means that repeat orders can be costed very precisely and delivered in accordance with market requirements.

### The versatility of the LASERTEC 50 PrecisionTool

With a view to increasing process optimization, Gabriele Borri is already thinking ahead: "We would like to use the LASERTEC 50 PrecisionTool for sharpening used tools in future." He is considering further investments, together with the next-generation management. His two daughters Laura and Elena will continue to run MICROTECH along with Luca Carciofi. "If we need a further increase in production capacity, another LASERTEC 50 PrecisionTool would definitely be an option."

## DIAMOND TOOLS WITH A SIGNIFICANTLY LONGER SERVICE LIFE

With regard to precision, the LASERTEC 50 PrecisionTool provides top-class machining results. It makes it possible to manufacture defined cutting edge radii of 3, 6, 9, 12 or 15  $\mu$ m and also negative chamfers. "The high-precision cutting edges give our tools even better quality," says Gabriele Borri happily. Laser

### MICROTECH FACTS

- + Established in Appignano in 1980
- + 30 experienced engineers
- + Development of high-precision PCD tools for wood machining



MICROTECH s.n.c  
Di Borri e Carciofi  
Via Leonardo da Vinci 21  
62010 Appignano (MC), Italy  
[www.microtechdia.com](http://www.microtechdia.com)



# INTO THE DEPTHS OF SPACE



“ Thanks to ULTRASONIC technology, we can produce mirrors up to two meters in size reliably and – up to ten times faster. ”

**Matthew White** (left)  
Senior Manager of Manufacturing Engineering  
Coherent Aerospace & Defense

**James Verrico** (right)  
CNC Manufacturing Staff Engineer  
Coherent Aerospace & Defense

Founded in 1971 and with a key location in Richmond, California, Coherent Aerospace & Defense specializes in the precision machining of optical elements and assemblies for aerospace and astronomical research. The company has 28,000 employees worldwide. Coherent A&D has been relying on the fast, high-precision ULTRASONIC technology from DMG MORI for glass machining, and with the acquisition of an ULTRASONIC 200 Gantry, the economical production of mirror segments for giant telescopes is now also possible.

**Precision machining for giant telescopes**  
New, larger optical telescopes with diameters of up to 30 meters are helping researchers look even deeper into space in order to answer fundamental questions in astronomy, astrophysics and cosmology. The challenge in building these giant telescopes is the

mirrors. “The initial shape of these segments is a round mirror with a diameter of one and a half meters and a thickness of just 45 mm,” explains Matthew White, Senior Manager of Manufacturing Engineering. “We shape this into a hexagonal form, known as hexing. Assembly features, such as sensor pockets, are also incorporated.”

Conventional machining of such glass materials has been carried out for many years on machining centers with diamond tools, albeit at a relatively slow speed. “With the large mirror segments and the enormous quantities, it would take us many years to equip an observatory this way,” calculates Mr. White. The ULTRASONIC technology from DMG MORI was seen as having the potential to drastically reduce the machining time. In ULTRASONIC machining, the diamond tool oscillates along its axis at a high frequency and low amplitude – in addition to the tool’s own high-speed rotation. “This enables us to remove material six to ten times faster. At the same time, tool life increases significantly,” says White. The process has long proven its worth in the semiconductor industry, for example. Coherent A&D has now transferred it to the machining of even larger glass components.

UP TO TEN  
TIMES FASTER  
PRODUCTION  
THANKS  
TO ULTRASONIC  
TECHNOLOGY

machining of the hexagonal mirror segments from which the entire mirror is assembled. These massive, light-gathering mirrors are comprised of hundreds of segmented

Machining of the hexagonal mirror segment from which the entire mirror for a giant telescope up to 30 meters is assembled.



The ULTRASONIC 200 Gantry offers travels of 4,000 x 2,000 x 1,200 mm. The stable foundation of the gantry construction is an optimal basis for the high-precision processing of the mirror segments

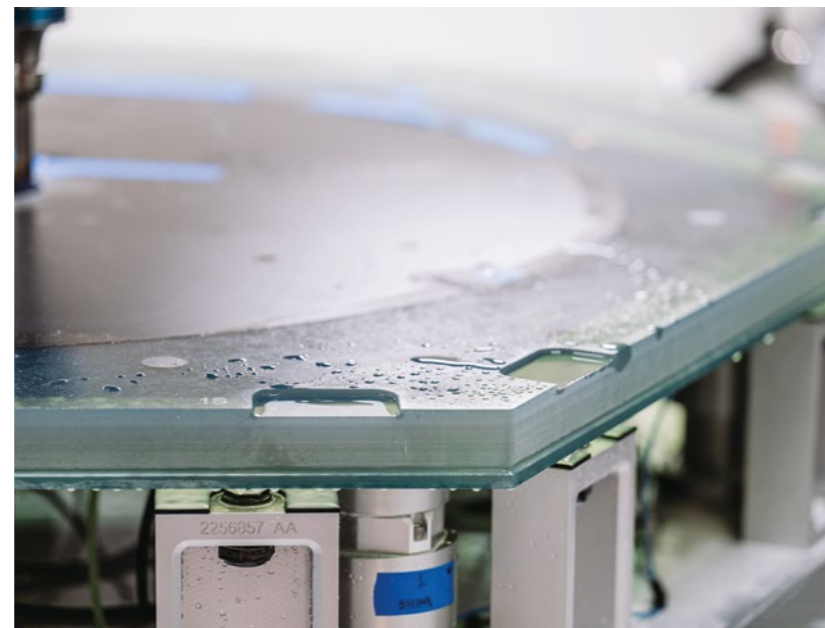

Assembly functions, such as sensor pockets, are also incorporated into the workpiece.



The engineers at Coherent developed a proprietary fixturing approach that uses a combination of support and clamping systems to fix the component.

ULTRASONIC 200 Gantry

## LARGE WORK AREA WITH SMALL SPACE REQUIREMENT

- + Maximum workpiece size of 4 m<sup>3</sup> (3-axis) or 2.2 m<sup>3</sup> (5-axis)
- + **Fully enclosed working area with integrated chip removal** and good visibility from the side
- + **High rigidity and dynamic milling** (5 m/s<sup>2</sup> acceleration in all linear axes) due to portal design
- + **Consistent milling characteristics** throughout the entire work area due to constant tool overhang in the Z-axis
- + **Integration of ULTRASONIC technology** possible in the 90° and 45° head

FOOTPRINT  
**27 m<sup>2</sup>**

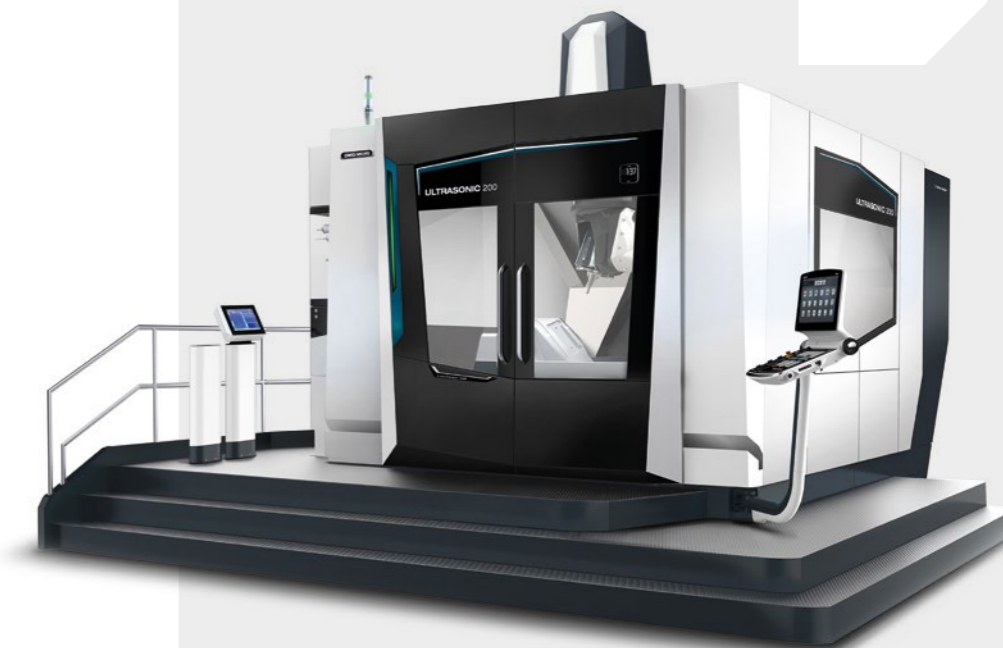

In ULTRASONIC machining, the diamond tool oscillates along its axis at a high frequency and low amplitude – in addition to the tool's own high-speed rotation.

### XXL machining on the ULTRASONIC 200 Gantry

DMG MORI has the ULTRASONIC 200 Gantry in its range for ultrasonic machining of large components. The machine is based on the DMU 200 Gantry and offers travels of 4,000 x 2,000 x 1,200 mm. The stable foundation of the gantry construction is an optimal basis for high-precision processing of the mirror segments. Coherent poured a new concrete floor for this purpose, which was additionally reinforced. "This ensures mechanical stability," explains White. "We have also improved the temperature control in the factory in order to achieve constant ambient conditions."

### Reliable clamping and machining

The biggest challenge, however, lies in the enormous diameter and thinness of the workpiece. "Using a normal clamping process, the component could warp," says Mr. White. The component could jump out of the fixture after being released, which would jeopardize the dimensional accuracy. Due to the asymmetrical and aspherical shape, a simple vacuum chuck is also not a suitable solution, so the engineers at Coherent developed a proprietary fixturing approach that uses a combination of support and clamping systems. White is very satisfied with the result: "This fixes the mirror segment in all degrees of freedom without causing unwanted bending." He added that

he is impressed by the machining results of the reliable process: "The ULTRASONIC technology significantly reduces the process forces thanks to the repeated interruption of contact between the tool and workpiece. On one hand, this ensures perfect surfaces and cutting edges because there is virtually no material chipping. On the other hand, it also perfectly accommodates the complex clamping concept."

### Partnership-based cooperation with DMG MORI at all levels

The reasons for investing in the large ULTRASONIC 200 Gantry model from DMG MORI were in part due to the good experience with the innovative machining technology. Additionally, there was already a good partnership with the machine tool manufacturer: "The response times for service are always good and the individual configuration options of the machines make selection easier," says Matthew White, assessing the cooperation. He would like to continue this for future investments. "The next step will be to expand our ULTRASONIC capacities with an ULTRASONIC 80 eVo *linear*."

«

### COHERENT AEROSPACE & DEFENSE FACTS

- + Coherent Corp.: 1971, Coherent A & D Richmond location: 1926, in Berkeley, CA
- + 28,000+ including engineers, scientists and technicians

**COHERENT**

Coherent Aerospace & Defense  
4000 Lakeside Drive,  
Richmond, CA, USA, 94806  
[www.coherent.com](http://www.coherent.com)



Technical Data		DMU 200 Gantry
Travel X/Y/Z	mm	2,000 (4,000*)/2,000/1,200
Rapid traverse X/Y/Z	m/min	50
Acceleration X/Y/Z	m/s <sup>2</sup>	5
Max. table load	kg	10,000 (20,000*)

\*optional



More information about the ULTRASONIC 200 Gantry can be found here: [ULTRASONIC-200-gantry.dmgmori.com](http://ULTRASONIC-200-gantry.dmgmori.com)

**WORLD  
PREMIERE  
2024**

# LASERTEC 30 SLM 3<sup>rd</sup> GENERATION 100% MACHINE TOOL DESIGN FOR SLM TECHNOLOGY

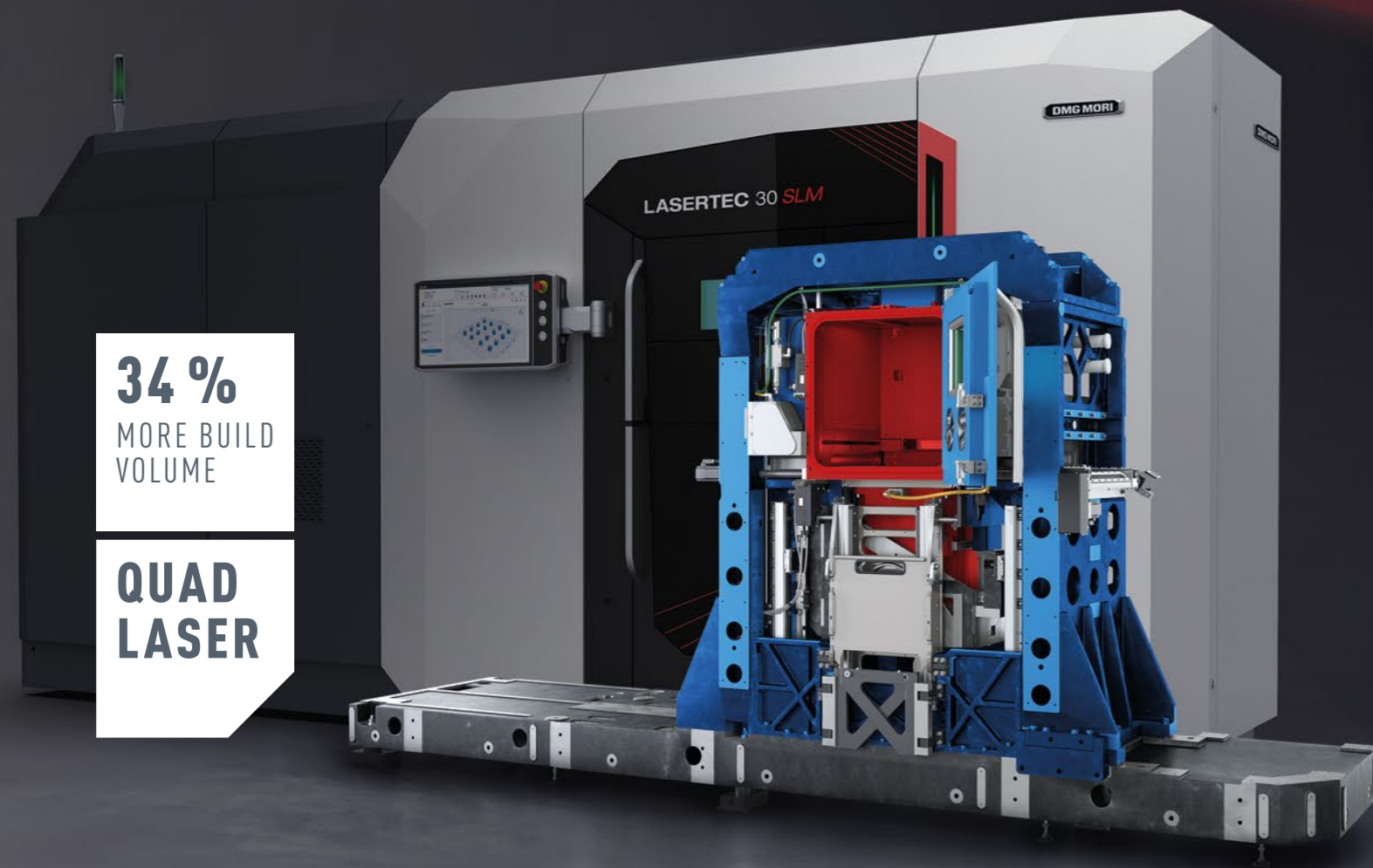

**34 %  
MORE BUILD  
VOLUME**

**QUAD  
LASER**

## HIGHLIGHTS

- + Build volume of 325 x 325 x 400 mm
- + Single-, Dual- or Quad-Laser rated at 600 W or 1,000 W
- + High-precision optics with 80 µm spot size and full overlap
- + rePLUG module for automated powder management under inert gas atmosphere
- + Material independent permanent filtration system
- + CELOS X with easyAM – managed workflows for easy machine operation and maintenance

## NEW: ACCURACY PACKAGE AS STANDARD

- + Thermosymmetrical cast frame for high rigidity
- + Floating process chamber for temperature stability
- + Z-axis with gantry concept and active temperature compensation

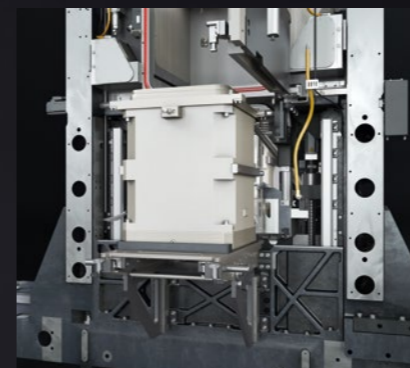
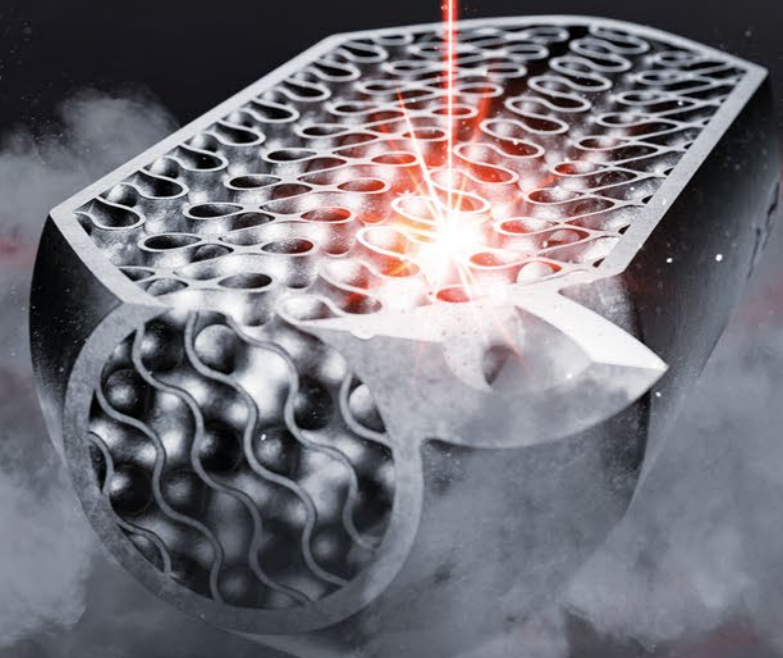

Exchangeable build container for reduced job-to-job time



Bi-directional recoater with collision protection system



## ADDITIVE INTELLIGENCE

START YOUR ADDITIVE SERIES PRODUCTION WITH US!

- + Identification of your application
- + Development of end-to-end process chains
- + From design to series production
- + Digitization and traceability with TULIP

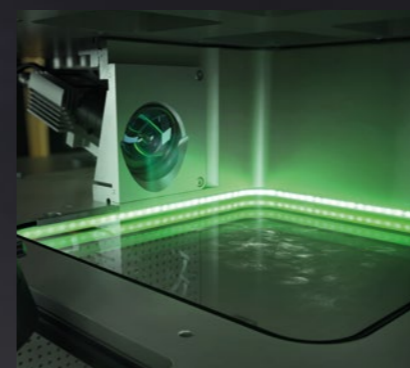

Unique protective glass monitoring system

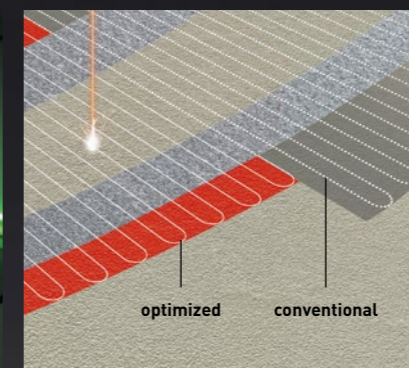

Optimized darkjumps for higher productivity

ALL APPS IN  
**CELOS X** *perience*

ALL DATA IN  
**CELOS X** *change*  
POWERED BY DMG MORI **CONNECTIVITY**

**NEW**  
ENERGY  
MONITORING  
OPTION IN THE  
MESSENGER



# CELOS X

THE FUTURE-  
PROOF  
PRODUCTION  
SOLUTION



**EASY**  
OPERATION

## ERGoline X

Innovative & ergonomic control panel  
for any control system

- + Standardized user interface with access to CELOS Xperience on all CNC controls
- + Seamless integration of applications and DMG MORI technology cycles into CELOS X



**EXTENDED**  
SPINDLE HOURS

## CELOS X Widgets

Perfect synergy: process integration meets ease of use

- + Visualization of technology cycles & sensor data next to the NC control
- + Increased process reliability thanks to integrated process data, including alarms & limits
- + Available for Machine Protection Control (MPC), Easy Tool Monitor 2.0 & Drive Load Display



**ENERGY**  
EFFICIENCY

## DX meets GX

From Digital Transformation (DX) to Green Transformation (GX)

- + Energy monitoring: Measurement & visualization of energy consumption according to production status (production, standby, idle)
- + Advanced Energy Monitoring: Additional measurement & visualization of compressed air consumption

# ERGOline X

## INNOVATIVE CONTROL PANELS FOR EVERY CONTROL TYPE

### SMARTkey

- + Compact credit card format
- + Personalized access rights depending on user level
- + Independently customizable SMARTkeys

### APP LAUNCHER

Standardized user interface for CELOS X, independent of the CNC control.



# ERGOline X

ERGOline X was introduced with the launch of CELOS X and offers the machine operator an even more intuitive user experience than its predecessor. The ERGOline X gives the user access to CELOS Xperience and the native CNC control. This paves the way for an intuitive user experience for a multitude of current and future applications.

#### Intuitive user interface

The intuitive and user-friendly user interface of CELOS Xperience is reminiscent of familiar smartphone interfaces and invites interaction. Easy access to all relevant information and applications reduces the fear of collision during the operation of complex machine tools. The seamless integration of apps and DMG MORI technology cycles in CELOS X directly on the control increases the efficiency and effectiveness of the machine operator and simplifies the operation of the machine tool.

When developing the new ERGOline X panels with a 24" display, the focus was on ergonomic arrangement, safety and user experience. Innovative operating elements, such as the SMARTkey and SMARTride, enable the highest safety standards and facilitate easier handling of complex machine tools.

#### Comprehensive functionality

CELOS Xperience offers a wide range of functions that go beyond the simple control of the machine tool. From process optimization in the environment of machines and workstations through to the no-code programming of virtual workflows with TULIP, CELOS Xperience enables comprehensive digitalization and optimization of manufacturing processes.

The new SMARTride makes machine operation even safer, more efficient and ergonomic. Instead of the two rotary knobs, employees now control feed and rapid traverse using a single button with haptic feedback. This gives the operator a better ergonomic position in relation to the machine and allows them to focus on the workpiece or the infeed process.

#### Seamless Integration

CELOS Xperience and the native CNC control system integrate seamlessly into the ERGOline X control panel. This makes operating the machine tool simpler and more efficient. Thanks to the constantly expanding integration with other systems and software solutions and flexible customization of views, DMG MORI ensures efficient communication and data exchange across the entire production environment.

The infeed process is made safer and more efficient thanks to "conditional stops" and the "panic function". The desired stop conditions in the running NC program can be determined individually thanks to the intelligent software and make it possible to avoid errors. The panic function reduces the feed and rapid traverse directly to 0% without having to move the SMARTride to a 0% position manually. The revised arrangement of the operating elements and the use of the latest touch technology make operation a real experience. On request, the control panels of milling machines with SIEMENS and HEIDENHAIN can be equipped with two conventional potentiometers for feed and rapid traverse.



24" ERGOline X Panel with HEIDENHAIN



24" ERGOline X Panel with MAPPS



**MAPPS**  
Haptic keyboard & new HYBRID BAR for enhanced operability

**SIEMENS/HEIDENHAIN**  
Feed, Rapid Traverse & NC Start in one control with SMARTride

### SMARTride\*

- + Integrated panic function to instantly reduce the feed rate / rapid traverse to 0
- + Integrated haptic feedback to recognize 0% & 100%
- + Feed rate, rapid traverse & NC-start combined in one control element

\*Only available with control systems from SIEMENS or HEIDENHAIN

24" ERGOline X Panel with Sinumerik ONE and CELOS X





## OP WORKBENCH - THIS IS HOW PROGRAMMING WORKS TODAY!

Unprecedented simplicity in the design and process optimization of NC programs, it's simply great! Anyone can now follow the program sequence in seconds.

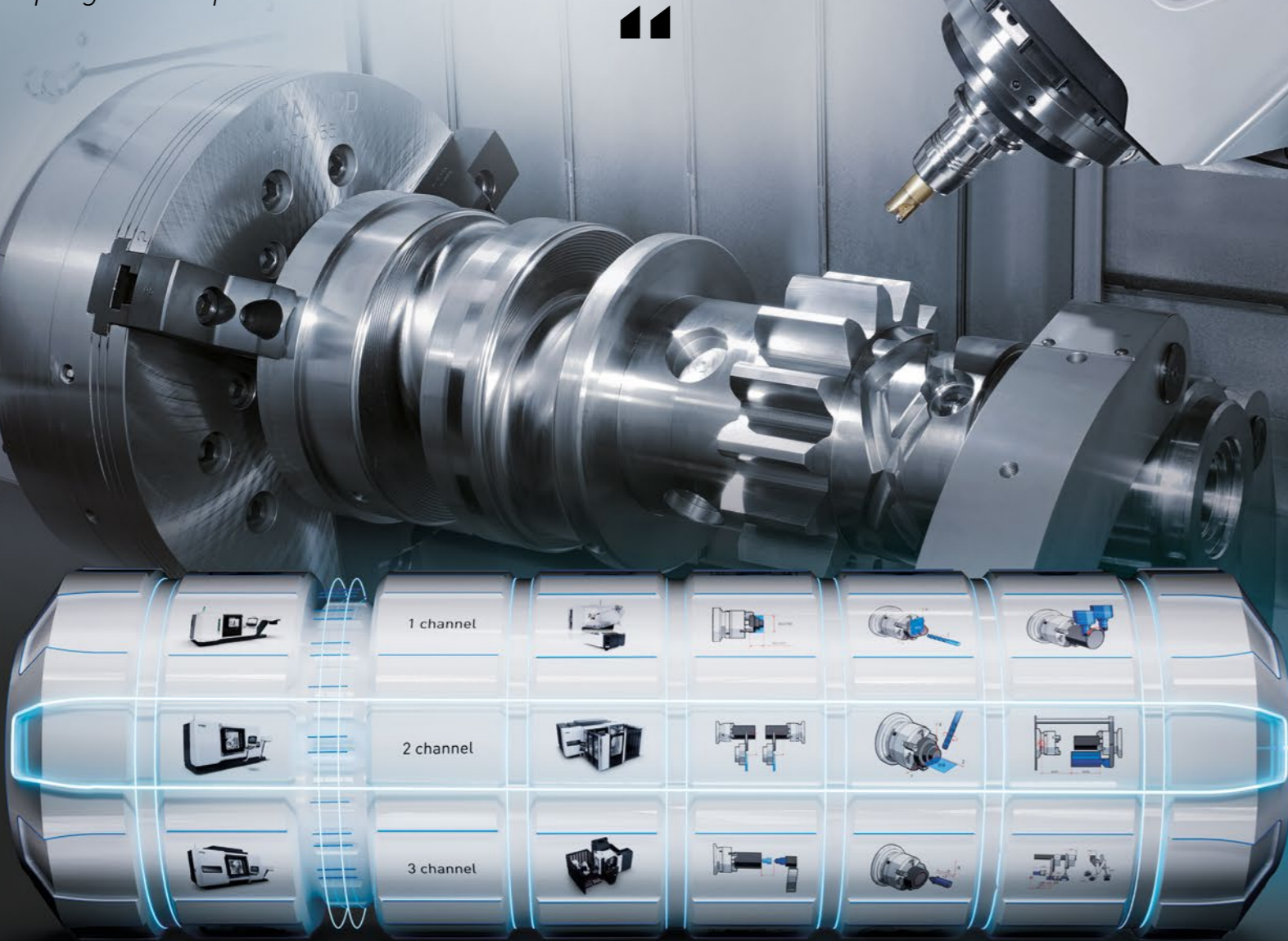

OP Workbench: The clear and easy-to-understand solution for intuitive programming using drag & drop, regardless of the complexity of the processes.



OP Workbench is available for all CLX TC/CTX TC machines with CELOS V6/CELOS X and SIEMENS.

- 1 SELECT PROJECT TEMPLATE
- 2 ENTER FIXTURING PARAMETERS
- 3 PLAN OPERATION
- 4 SEND TO THE NC

# 3D SHOPFLOOR PROGRAMMING

UP TO 80% FASTER SHOPFLOOR PROGRAMMING THANKS TO AUTOMATED FEATURE RECOGNITION

STANDARD AND EXCLUSIVE ON DMG MORI MACHINES

The new capability of the controller has taken shopfloor programming to a completely new level.



Available in combination with Sinumerik ONE

1 LOAD 3D MODEL

2 DEFINE RAW MATERIAL

3 SET PROCESS PARAMETERS

4 SIMULATE NC PROGRAM

5 RUN NC PROGRAM

# TULIP

## THE DIGITAL TOOLBOX FOR INDIVIDUAL APPLICATIONS IN MANUFACTURING

In these times of a shortage of skilled workers and increasing pressure to optimize, the digitalization of manufacturing processes is a necessary measure. Its implementation is increasingly taking place through the use of agile and adaptable solutions.

TULIP connects people and machines in digital processes and makes real-time data from production available everywhere. Applications are designed for individual workflows and the real-time data obtained is used for continuous process improvement. TULIP enables manufacturing companies to easily design and introduce a modern MES system with team knowledge.

Users become developers and create fully functional industrial applications with over 100 customizable app templates without any programming knowledge. The integration of machines, systems and IoT devices into existing IT systems is also possible via interfaces.

Digital assembly instructions or guided quality checks can be used to reduce errors in manual production activities. Simple guided setup instructions and apps for machine monitoring, OEE calculation or recording reasons for downtime can optimize production times and capacity utilization.

### HIGHLIGHTS

- + Creation of apps for every use case & any complexity
- + Digital mapping, provision and secure storage of expert knowledge
- + Reduction of errors through improved quality control
- + Making real-time data from production available everywhere



Jetzt Termin vereinbaren:  
[tulip.dmgmori.com](http://tulip.dmgmori.com)



“  
The introduction of TULIP has enabled us to optimize the **complete manufacturing process in a sustainable way**: From PRODUCTION PLANNING to material management and assembly – better than any ERP system.”

Sven Donner  
Production manager at VETEC Ventiltechnik GmbH  
now Project Director at SAMSON AG

## TULIP FOR LOGISTICS, MONITORING & QUALITY ASSURANCE



INCOMING & OUTGOING GOODS INSPECTION

REAL-TIME ORDER TRACKING

MACHINE & PRODUCTION DATA

GUIDED WORK INSTRUCTIONS

QUALITY DATA ACQUISITION



“  
With TULIP, we have already been able to make a large number of our processes completely paperless. With this digitization step, we have succeeded in drastically reducing the amount of training required for machine operation.”

Michael Winkelbauer  
Managing Director at Winkelbauer GmbH

### TULIP APPS IN CELOS X

Start your free TULIP trial version for CELOS X with ready-to-use and exclusive TULIP Apps in CELOS X.\*

START YOUR FREE TRIAL NOW!



## TULIP APPS IN CELOS X FOR YOUR DMG MORI MACHINE

The TULIP apps support users in the optimized operation of their machine through guided workflows – exclusively for use on the user interface of the CELOS X platform. TULIP Guide Apps ensure optimal use of the exclusive DMG MORI technology cycles, such as 3D quickSET and VCS Complete, through guided workflows. TULIP apps for shift management simplify daily tasks around the machine and make them more efficient thanks to documentation and organization functions. With TULIP Apps and CELOS X, users can easily get started with paperless and connected production.

### HIGHLIGHTS

- + Improved component quality & optimized machine runtime
- + Fast & easy documentation of process and machine incidents
- + Increased process reliability thanks to cycle entries using the simple copy & paste feature

\*Available in DACH, EU, UK for SIEMENS and HEIDENHAIN, depending on the CELOS X version (update may be required).



Try for free:  
[dmgmori.com/tulipinCELOS](http://dmgmori.com/tulipinCELOS)

# FLYING COMPONENTS PROGRAMMED VIRTUALLY

Helicopters have had a permanent place in the long history of Airbus since the 1960s. The Donauwörth site also looks back on a history characterized by aviation technology. 1972 saw the establishment of Messerschmitt-Bölkow-Blohm GmbH (MBB), in 1989 Deutsche Aerospace (DASA) acquired a stake in the company and in 1992 MBB merged with French Aérospatiale to form the Eurocopter Group. This became part of the EADS Group in 1999. As part of the restructuring and renaming to Airbus Group and later Airbus, Eurocopter became today's Airbus Helicopters GmbH in 2014. Around 8,000 employees are responsible for the development and construction of helicopters for civil and military use at the location in Donauwörth. Machining processes are brought to series maturity and certified for each new component in mechanical production, so that production can also take place at other locations in compliance with all safety regulations.

»

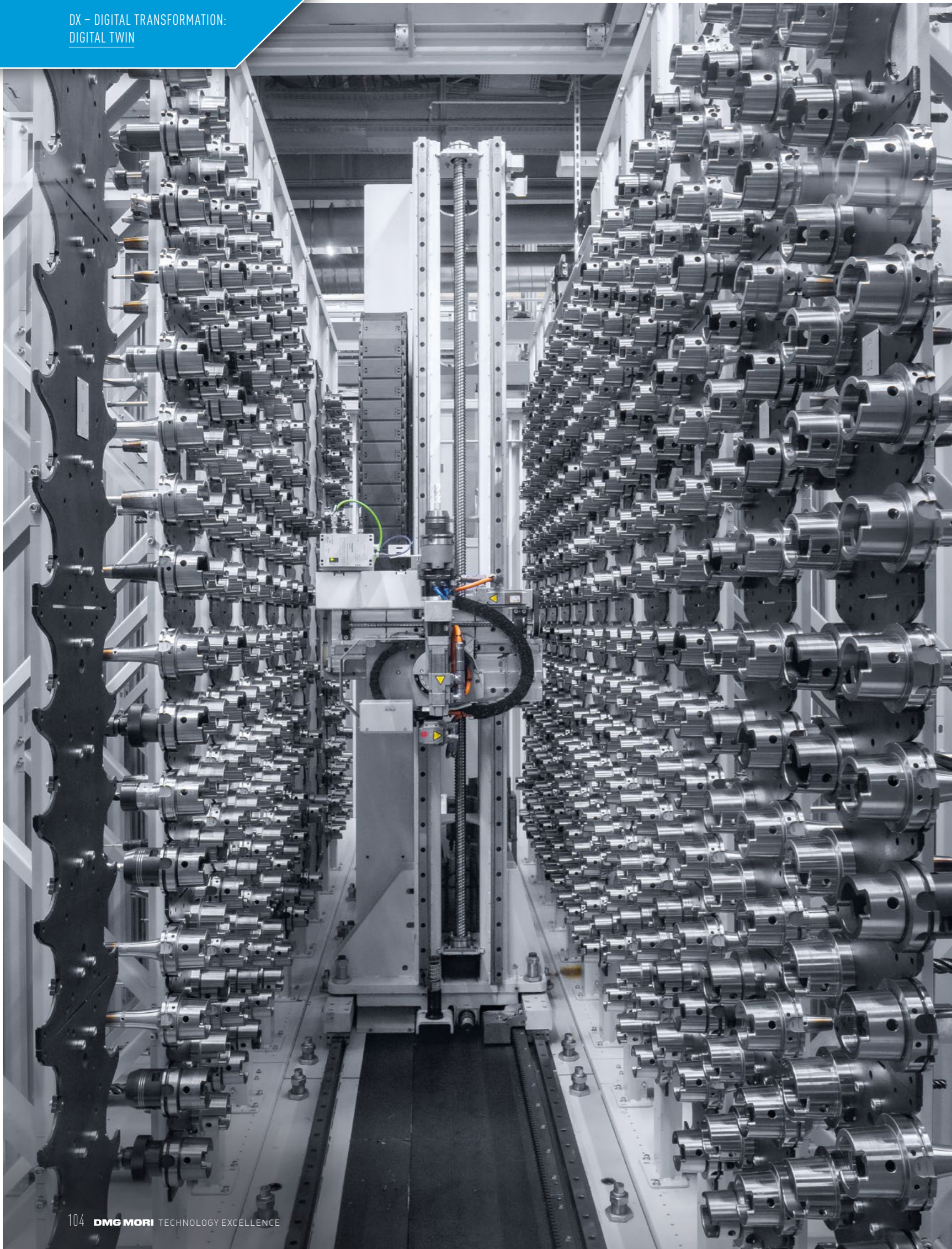

External tool magazines with 800 locations for steel/titanium machining and 1,000 locations for aluminum machining offer sufficient storage space for sister tools.

**Machine tools from DMG MORI have always played a decisive role in the machining of the high-quality components made of titanium, steel and aluminum. Among other things, two pallet pool systems were installed for this purpose, each with five DMC 80 U duoBLOCK and DMC 80 H linear centers. In the process configuration for new components, Airbus Helicopters relies on the DMG MORI Digital Twin, which guarantees reliable and efficient manufacturing.**

**Certified manufacturing processes for safety-critical components**

The safety of aircraft and helicopter passengers has always been a top priority for Airbus. This places extremely high demands on the technical expertise of the specialists and the quality of the sophisticated components in the early production stage. "We only use the highest quality steel, titanium and aluminum alloys," explain Thomas Heinrich and Steffen

Rössner, both responsible for programming in mechanical production at Airbus Helicopters. As the workpieces are exclusively safety-critical components, machining is

**AUTOMATED PRODUCTION ON TWO PALLET POOL SYSTEMS WITH FIVE MACHINING CENTERS EACH**

carried out in frozen processes. "This means that once components and their manufacturing processes have been certified, nothing can be changed – neither programs nor tools."

A major challenge in production at Airbus Helicopters is to ensure the most efficient and reliable production configuration for new components. With two manufacturing lines designed by DMG MORI, the team can maintain production of the components in three shifts. Each system has four set-up stations. The high rack levels offer space for 80 pallets each. In addition to the large tool magazines of the five DMC 80 U duoBLOCK and DMC 80 H linear centers, external tool magazines with 800 locations for steel/titanium machining and 1,000 locations for aluminum machining provide sufficient storage space for sister tools. "The runtimes for each machining step are included in the programs so that the system calls up new tools in good time before the stored tool life is exceeded," says Steffen Rössner.

»



Components made of titanium, steel and aluminum are machined on two pallet pool systems, among others.

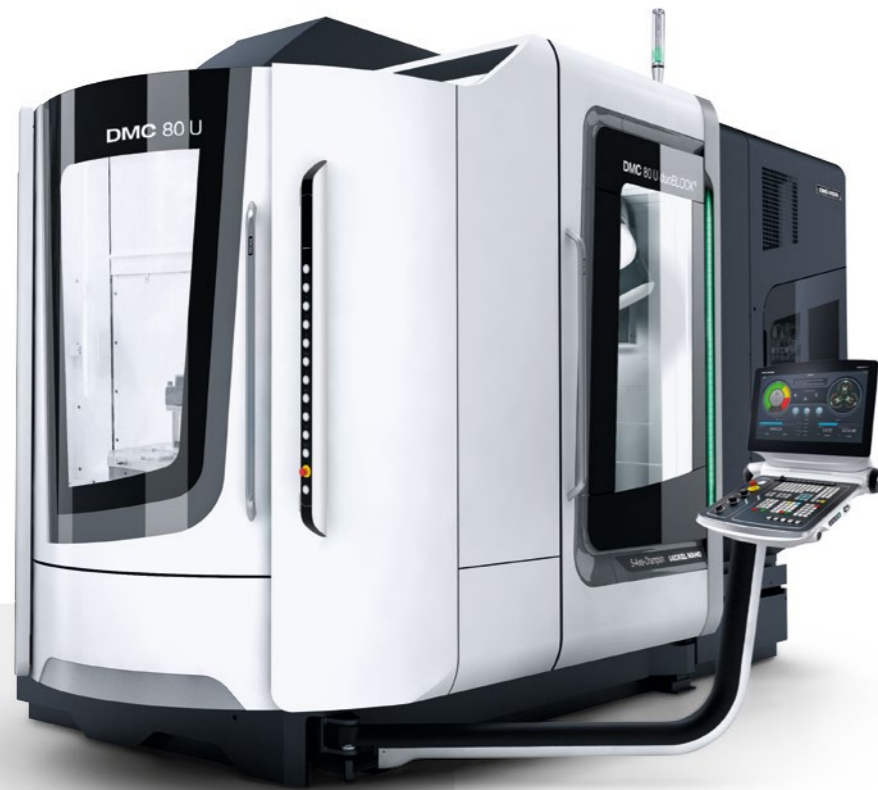

DMG 80 U duoBLOCK

## duoBLOCK – THE BENCHMARK FOR ALL INDUSTRIES

- + Workpieces up to  $\varnothing 900 \times 1,450$  mm and 1,500 kg
- + speedMASTER spindles up to 30,000 rpm or 200 Nm, powerMASTER spindles up to 16,000 rpm and 1,000 Nm, or 5X torqueMASTER spindles with up to 1,300 Nm
- + Maximum rigidity for exceptional machining performance
- + Integrated cooling concept for maximum long-term precision
- + 5 in 1 process integration: 5-axis milling, turning, grinding, gear cutting and in-process measurement
- + Versatile automation solutions – also retrofittable



You can find a duoBLOCK video at:  
[youtu.be/Ql0LzkJXUAY](https://youtu.be/Ql0LzkJXUAY)

### DMG MORI Digital Twin: Process simulation in the exact machine mirror image

Thomas Heinrich and Steffen Rössner use SIEMENS NX in the central programming department, including the simulation options available. "Since only the NC code is interpreted, without the software knowing the exact machine environment or the control system, these simulations have their limits," says Thomas Heinrich. Airbus Helicopters found an optimal solution in the Digital Twin from DMG MORI. It represents the digital mirror image of an individual DMG MORI machine tool. This mirror image contains the work area with all components, including all functionality such as movements and control functions as well as the NC and PLC and their cycles.

### Reduced costs thanks to faster production ramp-up, collision-free run-in and realistic training

"The exact 1:1 simulation of the programs brings us significant advantages," emphasizes Steffen Rössner. "We can be sure that the process on the machine is collision-free and we achieve a significantly faster production ramp-up thanks to the virtual tests, while the systems continue to produce." With a view to avoiding collisions, Thomas Heinrich adds: "The license for the Digital Twin certainly pays off if a major crash is avoided thanks to the simulation." He mentions another advantage as well: "We can

use the Digital Twin to identify unused production potential and develop it digitally." In DMG MORI's opinion, the functionality of the Digital Twin goes far beyond this. The strengths of the software also come to bear where training is concerned, for example. Realistic training to avoid unproductive machine hours is a significant cost benefit for companies.

## SAFE PRODUCTS AND PRODUCTION PROCESSES THANKS TO THE DMG MORI DIGITAL TWIN

The possibilities of the DMG MORI Digital Twin fit perfectly into the day-to-day business and the philosophy of Airbus Helicopters. "The safety of our products has top priority. This applies likewise to our manufacturing processes," says Thomas Heinrich, linking the two aspects. "The Digital Twin is the perfect tool to guarantee this level of safety."

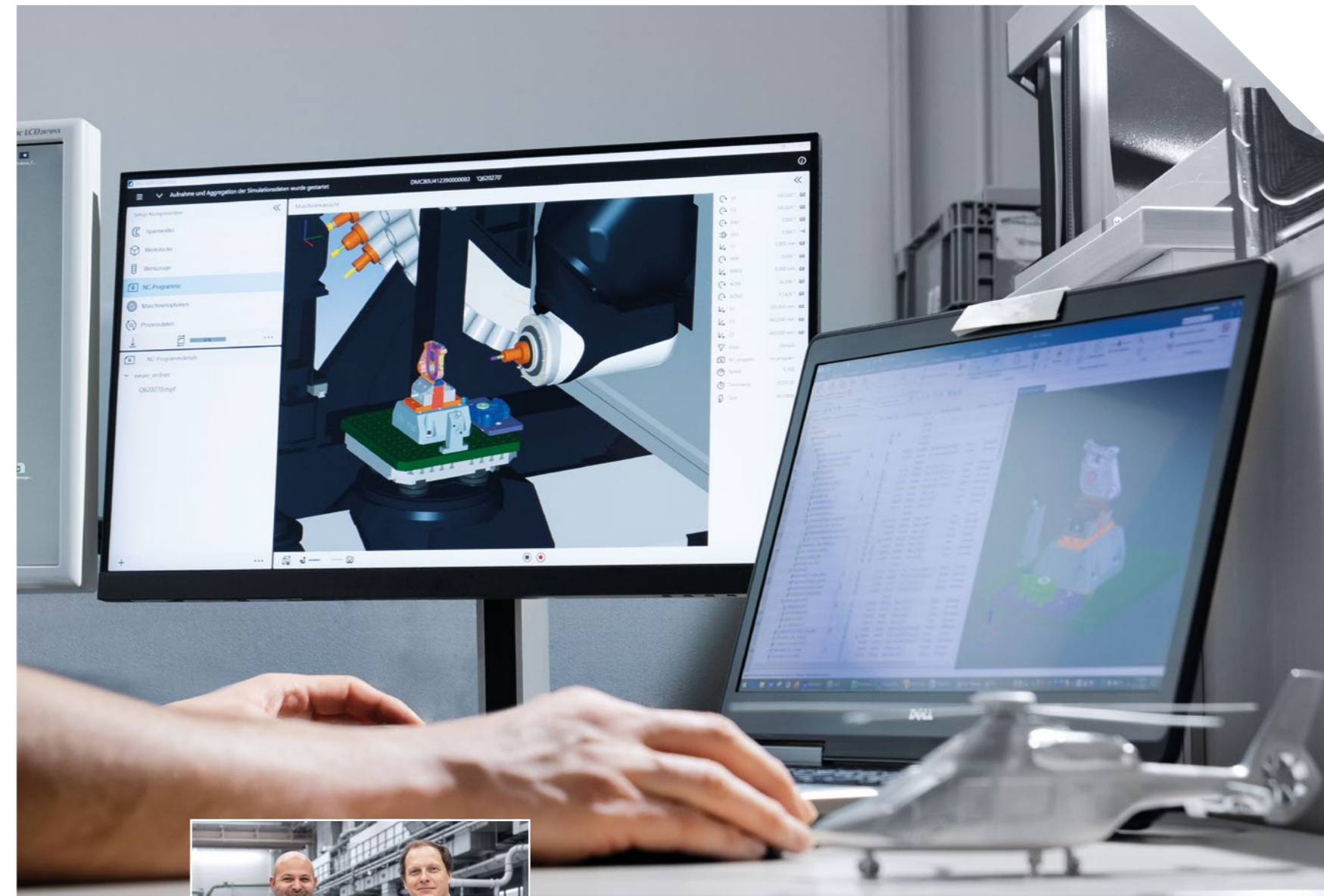

DMG MORI Digital Twin: Process simulation in the exact machine mirror image incl. NC, PLC and their cycles.



*With the Digital Twin, we were able to reduce the ramp-up time for new components significantly, while the possibility of a crash is virtually eliminated.*

**Steffen Rössner and Thomas Heinrich (on the right)**  
both responsible for programming in mechanical production at Airbus Helicopters



### AIRBUS HELICOPTERS DEUTSCHLAND FACTS

- + Expertise in the production of helicopters since 1972, initially as Messerschmidt-Bölkow-Blohm GmbH (MBB), from 1992 as Eurocopter and since 2014 as Airbus Helicopters
- + 8,000 employees at the Donauwörth plant for the development and manufacture of helicopters



Airbus Helicopters Deutschland GmbH  
Industriestraße 4  
86609 Donauwörth, Germany  
[www.airbus.com](http://www.airbus.com)



# FEEL THE POWER OF GREEN TRANSFORMATION (GX)

## WHY MX – MACHINING TRANSFORMATION?

Integrated processes increase productivity, minimize energy consumption and maximize profitability. With our **GREENMODE** measures, DMG MORI machine tools can achieve remarkable energy reductions of up to 30%.

## PROCESS INTEGRATION

Extended spindle hours with higher utilization of a single machining center by complete machining, instead of partial utilization of several simple machines.

## AUTOMATION

Extended spindle hours with additional, minimally-attended shifts, e.g. nights/weekends. Often one automated system can replace three or more stand-alone machines.

## DIGITIZATION

Holistic solutions for the entire production process: Increase the utilization of your machine and detect & avoid machine downtimes.

UP TO  
**30%**  
ENERGY SAVINGS  
POSSIBLE

## SELECTED GREENMODE MEASURES

1. Braking Energy Recovery
2. LED Lights
3. Low GWP Refrigerant
4. Advanced Auto Shutdown
5. Adaptive Feed Control
6. Advanced Energy Monitoring
7. Air Leakage Monitoring
8. Frequency-Controlled Pumps
9. **zero-sludge**COOLANT
10. Adaptive Coolant Flow
11. **zeroFOG** Mist Collector
12. AI Chip Removal

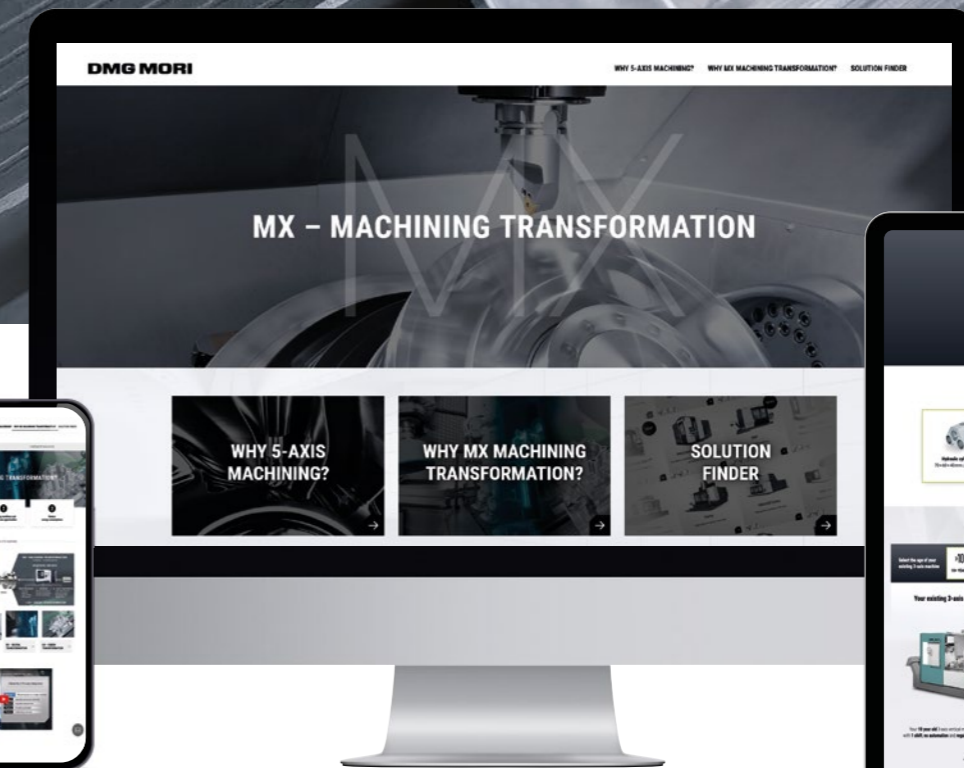

You can find our web special at:  
[transform.dmgmori.com](https://transform.dmgmori.com)

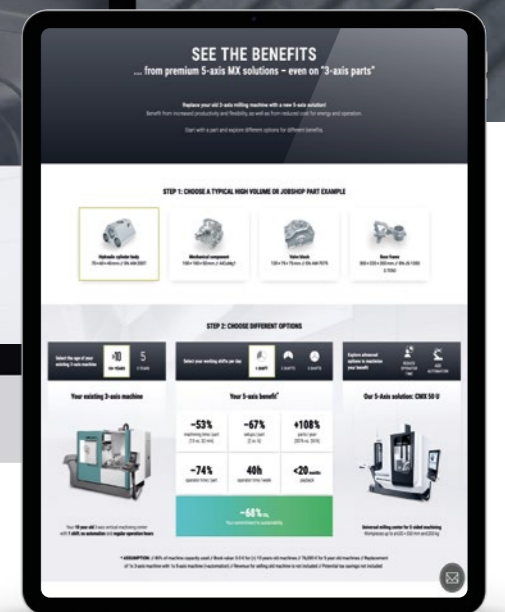

## EXPLORE THE WORLD OF MX

[transform.dmgmori.com](https://transform.dmgmori.com)

**BENEFIT OPTIMIZER**  
Experience the benefits of premium 5-axis MX solutions and find the perfect match for your requirements.

Two robots handle the workpieces at the center of the MATRIS system. The panels are aligned and automatically clamped in the device at both sides. The two panels that have already been machined are removed and transferred to the other stations.

# AUTONOMOUS SERIES PRODUCTION FOR E-MOBILITY



from unmachined part to production, washing, quality inspection and deburring to the final, unique marking of the components.

## Precision from tradition in the 4<sup>th</sup> generation

The range of services provided by PWS has developed continuously over the decades. "We have constantly expanded our product range, particularly in terms of materials," explains Daniel Jud, who is a member of the fourth generation to run the company as a managing partner. His great-grandfather started processing black steel and stainless steel followed later. "Aluminum and titanium are becoming increasingly important nowadays." The trend towards lightweight construction is being driven forward by the electric vehicle industry, for example.

## INSPIRING YOUNG TALENT WITH MODERN MACHINE TOOLS

In prototype manufacturing, PWS supports its customers in the early stages of development. The team is constantly faced with new challenges when machining innovative components with maximum quality as well as economically, prior to series production. Daniel Jud thinks that his team and the production area are well prepared for this: "On one hand, we benefit from the many years of know-how of our specialists and on the other from our high-performance manufacturing technology."

It was clear from the beginning that we needed full automation in order to ensure that we had reliable series production. We have found exactly the right partner for this in DMG MORI.

Daniel Jud, Managing Partner (right)  
Steffen Metz, Head of Purchasing and  
Materials Management  
at PWS Presswerk Struthütten GmbH

After its establishment 85 years ago, PWS Presswerk Struthütten GmbH from Neunkirchen quickly developed into a Full Service supplier in the areas of forming, joining and cutting. As a partner in both development and series production, the company and its 200 skilled staff supply customers in demanding industries - including the automotive, commercial vehicle and heating sectors. PWS started machining in 2022 after receiving an order for the production of floor components for the batteries of hybrid vehicles. The highly automated, precision production of these components takes place in a total of four NHX 8000 machines, which DMG MORI has connected via a MATRIS system. The productive automation includes the handling of the panels







Each NHX 8000 has a pallet changer with one fixture per pallet, each of which is equipped with a panel at both sides. Two floor panels are manufactured in a single machining process.

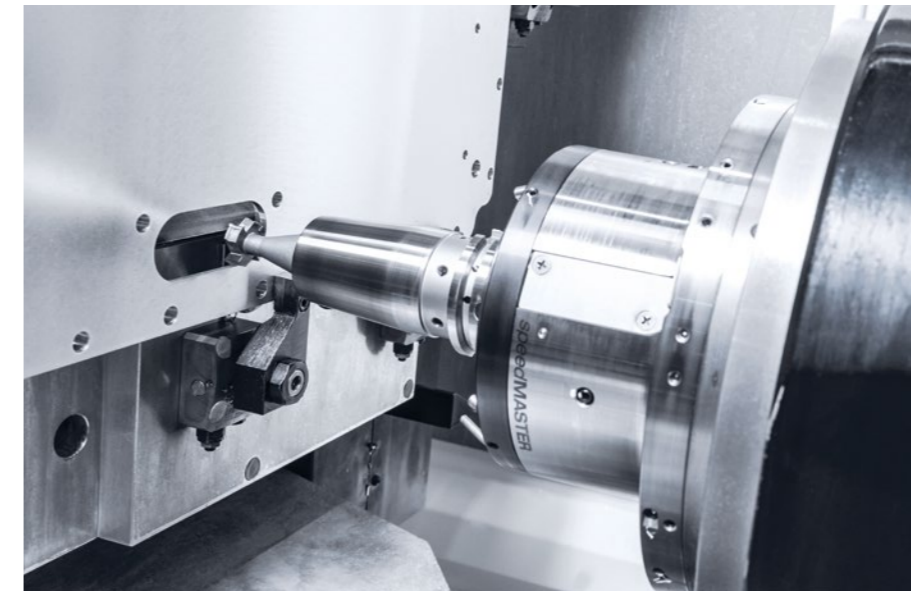

The NHX 8000 machines at PWS are equipped with #40 speedMASTER spindles as a special option.

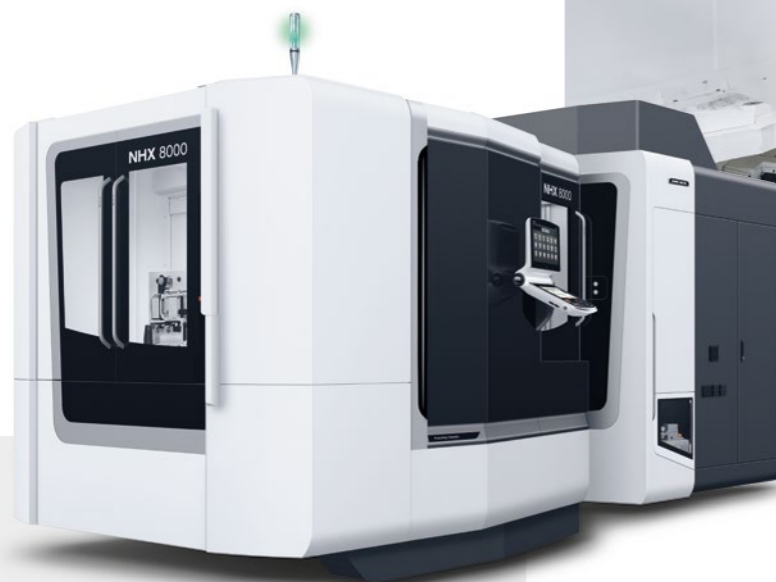

NHX 8000

**LARGE WORK AREA FOR WORKPIECES UP TO  $\varnothing$  1,450 x 1,450 mm**

- + 800 x 800 mm pallet size with maximum load of 2,000 kg
- + powerMASTER spindles up to 16,000 rpm or 1,413 Nm, speedMASTER spindles up to 20,000 rpm or 250 Nm as a special option
- + Tool magazine with up to 330 pockets
- + Versatile automation solutions – can also be retrofitted
- + CELOS with MAPPS or CELOS with SIEMENS



A video of the NHX series with the "MATRIS" robot system can be found at: [youtu.be/vtWcMJR4H8](https://youtu.be/vtWcMJR4H8)

The modern machines in the factory are also attractive for young talent and trainees. "We are fortunate to continue receiving unsolicited applications which allow us to fulfill our personnel requirements."

**DMG MORI: Flexible manufacturing solution with standard machinery**

One of the new machines has led to PWS expanding its technology portfolio to include innovative machining. "We produced a prototype of a floor component for the battery for a large automobile manufacturer and ultimately received the order to manufacture the series," remembers Steffen Metz, Head of Purchasing and Materials Management at PWS. "We were looking for a suitable manufacturing solution for this." Our core business of punching did not technically meet the requirement and processing in a gantry machine was too inflexible for us. "In DMG MORI, we have found a partner who can reliably supply equipment to produce the components to the required quality on standard machines, which has been verified by test machining in Wernau and now also in series production, of course." The choice was quickly made to machine the part on an NHX 8000. Its work area provides sufficient

room for the 652 x 980 mm components and, if necessary, the horizontal machining center will easily be able to be used for other jobs in the future.

The series production of the floor components involves up to 6,000 components per week. In order to be able to provide this capacity, PWS has purchased four NHX 8000 machines. Each has a pallet changer with one fixture per pallet, each of which is equipped

**MATRIS:  
INDIVIDUAL AUTOMATION SOLUTION FOR AUTONOMOUS OPERATION**

with a floor component at both sides. Two floor components are manufactured in one machining process. The decisive reason for selecting DMG MORI as a partner in this project was the automation expertise of the machine tool manufacturer.

Steffen Metz says: "It was clear from the start that we needed fully automated production in order to ensure process-reliable series production." With the MATRIS system, DMG MORI designed an individual solution and also delivered the entire manufacturing process as a turnkey project, and all from a single source.

**From the unmachined part to the ready-to-install floor component, including digital documentation**

PWS transfers the unmachined parts into the system using a special load carrier developed in-house with room for more than 100 panels. Two robots handle the workpieces at the center of the MATRIS system. The components are aligned and automatically clamped in the fixture at both sides. The two components that have already been machined are removed and transferred to the other stations. The finished parts are cleaned using a blow-off device, a camera inspection system checks the holes and the parts are processed in a deburring machine. Each panel is then laser-marked with a QR code and scanned. "We use this to record all production data digitally in order to guarantee complete traceability," says Steffen Metz.

"The smooth process provides floor panels that are ready to install." For further quality assurance, the MATRIS system was subsequently supplemented with a washing system and a flatness checker.

**Continuous production during maintenance**

Process reliability is crucial for PWS, since every machine downtime has serious consequences. Daniel Jud refers to the contractually agreed delivery quantities and deadlines: "This is why the production system was designed so that it can continue to work independently, even if a machine is not in operation, which is the case during maintenance, for example."

**Cooperative project**

DMG MORI completed the complicated turnkey design and progressed the project through to series production in the complex automation solution in approximately 18 months. One of the NHX 8000s was even delivered in advance so that PWS could manufacture the initial floor components and test the process. "This allowed us to gather some important information before final acceptance took place in Japan and incorporate

the findings into the construction of the system," says Steffen Metz about the cooperation provided by DMG MORI. By starting the machining of high quality, sophisticated components, PWS has looked outside the box and embarked on a path for which Daniel Jud has high expectations: "With the experience we have gained over the past two years in a technology area that is new to us, we believe that we are well prepared for future orders and further investment in innovative manufacturing solutions."

**PWS PRESSWERK STRUTHÜTTEN FACTS**

- + Founded in Neunkirchen in 1937
- + 200 skilled staff
- + Full service supplier in the areas of forming, joining and cutting
- + Supplier to the automotive, commercial vehicle and heating industries, among others



PWS Presswerk Struthütten GmbH  
Im Wiesengrund 7  
57290 Neunkirchen, Germany  
[www.pws.gmbh](http://www.pws.gmbh)



# SOCIAL ENGAGEMENT: PROSTHETICS FOR SOUTH AMERICA

DMG MORI has been involved as a partner in the promotion of young talent for many years. Desert View High School in Tucson, Arizona, is an impressive example of how early this support starts. The school launched the Advanced Machining iSTEM Academy in 2016 to familiarize students – both theoretically and practically – with professions in the industrial environment. Eight students are currently working on a project dedicated to the production of prosthetic legs for Latin American countries. The team is using a CMX 1100 V from DMG MORI to manufacture an important component of these prosthetics. As a partner in this project, the DMG MORI Academy has trained the teacher responsible, Cesar Gutierrez, who is now passing this knowledge on to the students.

“At the Advanced Machining iSTEM Academy, we don’t just want to teach students. It’s about inspiring and motivating them to develop personally,” says Cesar Gutierrez, explaining the ambitions of Desert View High School. Our students are demonstrating remarkable resilience and determination despite facing significant challenges. Their ability to persevere and thrive under difficult circumstances is truly inspiring and speaks volumes about their character and strength.

It is my goal to help students create opportunities for themselves that will ultimately lead to the pursuit of a career and a degree in higher education. I believe that a strong partnership with DMG MORI could greatly benefit our students and the community as a whole. By working together, we can create sustainable opportunities that will have a lasting impact.” Each NIMS (National Insti-

## OUR STUDENTS PROVE TO US THAT THEY ARE RESILIENT

tute for Metalworking Skills) credential a student earns is a step towards a better job and possibly a better future.” His commitment has earned Cesar Gutierrez a nomination as an Educator to the Manufacturing Ledger in 2021. The Manufacturing Ledger is part of the American Precision Museum in Windsor, CT, consisting of individuals who have impacted the lives of the next generation of manufacturers through classrooms and CNC program labs.

“*My vision is to empower students and make a positive impact on our community through education. It is my goal to help students create opportunities for themselves that will ultimately lead to the pursuit of a career and a degree in higher education.*”

**Cesar Gutierrez**  
Teacher  
at Desert View High School



CMX 1100 V

## RIGID C-FRAME CONCEPT FOR HIGH STABILITY AND PERFECT ERGONOMICS

- + Workpieces up to 1,400 × 560 × 630 mm and 1,000 kg
- + inlineMASTER spindle up to 15,000 rpm and 121 Nm, incl. 36 months warranty with no limit on running hours
- + Linear scales from now on as standard with 6 µm positioning accuracy in all axes



Desert View High School’s partnership with schools across the country to produce these prosthetics shows a commitment to collaboration and social responsibility. This kind of project not only provides essential medical devices but also helps raise awareness and build skills among students who are involved in the production process.



**Connecting the concepts of design, manufacturing and real-world applications**

One key to motivating the students is the choice of projects. "It's wonderful to hear how projects like the Life Changer Prosthetic have been able to transform the way students view their potential and the impact they can make in their careers and lives," says Cesar Gutierrez. "By connecting the concepts of design, manufacturing and real-world applications, students are able to see the direct connection between their creations and the positive impact they can have on someone's life." The Advanced Machining iSTEM Academy relies upon established relationships between industry and Pima Community College. This collaboration demonstrates the power of teamwork and the potential for creating even more meaningful projects in the future.

**DMG MORI  
ACADEMY –  
TRAIN THE TRAINER**

By working on a CMX 1100 V from DMG MORI, Desert View High School is also setting high standards at a technological level. "The students work with a state-of-the-art vertical machining center that is also easy to operate," says Cesar Gutierrez. He himself was trained by the DMG MORI Academy in the use of the machine and the control system – a MAPPS on FANUC – and now passes this knowledge on to his students. Using the CMX 1100 V, the students produce a cylinder that is crucial for the manufacture of the prosthesis. In doing so, they learn both the basics of machining technology and the importance of quality-oriented production. According to Cesar

Gutierrez, the vertical machining center meets all requirements in this respect: "Its stability guarantees precise production, as do the linear scales and the direct drive table as well as the comprehensive temperature compensation."

**Changing lives of people by creating affordable prosthetics**

"It's unfortunate that the FDA approval process of the Life Changer Prosthetic is too time-consuming and expensive, preventing it from being used in the United States," Cesar Gutierrez regrets. "However, it's commendable that it has been developed to address the urgent need for affordable prosthetics in Latin American countries, where amputee rates are high." The fact that the prosthetic can be produced at a significantly lower cost, around 700 dollars, makes it more accessible to those who otherwise would not be able to afford a prosthetic leg.

**Sustainable cooperation with DMG MORI**

On the whole, this project not only addresses the technical aspects of prosthetic design and manufacturing but also brings attention to the important issue of accessibility and affordability in healthcare. "By creating a more affordable option, you're making a significant impact on the lives of individuals in need," thinks Cesar Gutierrez. "This also contributes to the continued motivation of the students and it confirms the success of the Advanced Machining iSTEM Academy." This is why Desert View High School would like to extend the good and sustainable cooperation with DMG MORI. Cesar Gutierrez is already looking ahead: "As a next step, we could expand the project to include a lathe such as the NLX 1500 in order to introduce the students to this area of technology as well."



1. From left to right: Claudio Munoz III, Daziel Cordova, Bernadette Pinedo, Brianna Esqueda, Yarani Calderon, Principal Angelica Duddleston and Instructor Cesar Gutierrez 2. Students are testing a program for producing the cup for a below-the-knee prosthetic 3. Yarani Calderon testing a program for the new prosthetic

**DESERT VIEW  
HIGH SCHOOL FACTS**

- + Precision machining program in its 13<sup>th</sup> year
- + 130 students in the program, of whom 30 percent are female
- + 52 students in the Associate Degree in the Machine Tool Program at Desert View High School



Desert View High School  
4101 E Valencia Rd  
Tucson, AZ 85706, USA  
[www.susd12.org](http://www.susd12.org)



# DMG MORI FULL-SERVICE 5.0 YOUR ALL-ROUND CAREFREE PACKAGE

**All-inclusive, full cost control!** From service operations, spare and wear parts and annual maintenance to comprehensive protection against machine breakdown. DMG MORI Full-Service covers the first 5 years of your investment! Make use of this advantage – a **unique package exclusively for your new DMG MORI machine.**

## YOUR ADVANTAGES

- + All service and spare parts costs included
- + **Warranty extension to a total of 60 months**
- + Annual manufacturer maintenance included
- + **Immediate claims settlement by DMG MORI**
- + With DMG MORI Finance you can easily finance the Full Service when purchasing your new machine
- + 60 months free NETservice and remote service

## 5 YEARS CAREFREE



**PROTECTION IN THE CASE OF A CRASH INCLUDED**



**ORIGINAL SPARE PARTS INCLUDED**



**REPAIRS INCLUDED**



**TRAVEL EXPENSES INCLUDED**



**MAINTENANCE INCLUDED**

# FULL SERVICE

*Exclusive and unique for your new DMG MORI machine.*

**Sascha Mertins**  
Managing Director  
DMG MORI Global Service  
sascha.mertins@dmgmori.com



## Carefree production – these services are included!

REPAIRS	TRAVEL EXPENSES	ORIGINAL SPARE PARTS
		

Repairs, carried out without exception by our DMG MORI service technicians, are included.

➡ No repair costs

There are no travel expenses! All travel and ancillary costs are also covered by DMG MORI Full-Service.

➡ No travel expenses

Whether spare or wear parts – only our high-quality original spare parts are used on your machines.

➡ No costs for spare or wear parts

MAINTENANCE	COMPREHENSIVE COVER FOR CRASH & OTHER DAMAGE
	

Annual manufacturer maintenance including replacement of all necessary wear parts.

- + **Comprehensive manufacturer maintenance** by our service professionals
- + **Replacement** of all necessary wear parts such as scrapers, filters, filter mats and brushes
- + **The scope of maintenance** is adapted to the machine runtime **as required**

➡ No maintenance costs

Premium full protection in the event of machine breakdown. Immediate, carefree and complete claims settlement is guaranteed in the event of a crash.

- + **100% cost coverage**
- + Time savings thanks to **immediate claims approval** from your service region
- + **Immediate claims settlement** e.g. by installing replacement spindles
- + **€ 1,000 flat rate per claim**

➡ No additional service costs

## FACTS

- + The all-round service costs 2 to 3% of the list price of the machine per year.
- + Payments can be made annually or directly with the purchase of the machine.
- + Whether the customer utilizes the machine in single-shift or multi-shift operation is irrelevant to the cost of the service package
- + One contact for everything: The complete claims settlement and reporting is handled by DMG MORI.
- + For a crash or other damage, only €1,000 flat rate per claim